

12Gb/s SAS RAID Cards

ARC-1883 Series

(PCIe 3.0 to 12Gb/s SAS RAID Controllers)

User Manual

Version: 1.5

Issue Date: July, 2018

Copyright and Trademarks

The information regarding products in this manual is subject to change without prior notice and does not represent a commitment on the part of the vendor, who assumes no liability or responsibility for any errors that may appear in this manual. All brands and trademarks are the properties of their respective owners. This manual contains materials protected under International Copyright Conventions. All rights reserved. No part of this manual may be reproduced in any form or by any means, electronic or mechanical, including photocopying, without the written permission of the manufacturer and the author.

FCC Statement

This equipment has been tested and found to comply with the limits for a Class B digital device, pursuant to part 15 of the FCC Rules. These limits are designed to provide reasonable protection against interference in a residential installation. This equipment generates, uses, and can radiate radio frequency energy and, if not installed and used in accordance with the instructions, may cause harmful interference to radio communications. However, there is no guarantee that interference will not occur in a particular installation.

Manufacturer's Declaration for CE Certification

We confirm ARC-1883 has been tested and found compliant with the requirements in the council directive relating to the EMC Directive 2004/108/EC. Regarding to the electromagnetic compatibility, the following standards were applied:

EN 55022: 2006, Class B
EN 61000-3-2: 2006
EN 61000-3-3: 1995+A1: 2001+A2: 2005

EN 55024:1998+A1:2001=A2:2003
IEC61000-4-2: 2001
IEC61000-4-3: 2006
IEC61000-4-4: 2004
IEC61000-4-5: 2005
IEC61000-4-6: 2006
IEC61000-4-8: 2001
IEC61000-4-11: 2004

Contents

1. Introduction	10
1.1 Overview	10
1.2 Features	12
2. Hardware Installation	16
2.1 Before You First Installing.....	16
2.2 Board Layout.....	16
2.3 Installation.....	22
2.4 SAS Cables	31
2.4.1 Mini SAS HD SFF-8643 to 4xSATA Cable	31
2.4.2 Mini SAS HD SFF-8643 to 4xSFF-8482 Cable	32
2.4.3 Mini SAS HD SFF-8643 Cable	32
2.4.4 Mini SAS HD SFF-8644 Cable	33
2.5 LED Cables.....	33
2.6 Hot-plug Drive Replacement	37
2.6.1 Recognizing a Drive Failure	37
2.6.2 Replacing a Failed Drive	37
2.7 Summary of the installation.....	38
3. McBIOS RAID Manager	41
3.1 Starting the McBIOS RAID Manager	41
3.2 McBIOS RAID manager	42
3.3 Configuring Raid Sets and Volume Sets	43
3.4 Designating Drives as Hot Spares.....	43
3.5 Using Quick Volume /Raid Setup Configuration	44
3.6 Using Raid Set/Volume Set Function Method	45
3.7 Main Menu	47
3.7.1 Quick Volume/Raid Setup	48
3.7.2 Raid Set Function	52
3.7.2.1 Create Raid Set	53
3.7.2.2 Delete Raid Set	54
3.7.2.3 Expand Raid Set.....	55
3.7.2.4 Offline Raid Set	56
3.7.2.5 Activate Raid Set	57
3.7.2.6 Create Hot Spare.....	58
3.7.2.7 Delete Hot Spare	58
3.7.2.8 Rescue Raid Set	59
3.7.2.9 Raid Set Information	60
3.7.3 Volume Set Function	60

3.7.3.1 Create Volume Set (0/1/10/3/5/6)	61
• Volume Name	63
• Capacity	64
• Stripe Size	66
• SCSI ID	67
• Cache Mode	68
• Write Protect	68
• Tag Queuing	69
3.7.3.2 Create Raid30/50/60 (Volume Set 30/50/60)	69
3.7.3.3 Delete Volume Set	70
3.7.3.4 Modify Volume Set	71
3.7.3.5 Check Volume Set	73
3.7.3.6 Stop Volume Check	73
3.7.3.7 Display Volume Set Info.	73
3.7.4 Physical Drives	74
3.7.4.1 View Drive Information	75
3.7.4.2 Create Pass-Through Disk	75
3.7.4.3 Modify Pass-Through Disk	76
3.7.4.4 Delete Pass-Through Disk	76
3.7.4.5 Set Disk To Be Failed	76
3.7.4.7 Identify Selected Drive	77
3.7.4.6 Activate Failed Disk	77
3.7.4.8 Identify Enclosure	78
3.7.5 Raid System Function	78
3.7.5.1 Mute The Alert Beeper	79
3.7.5.2 Alert Beeper Setting	79
3.7.5.3 Change Password	80
3.7.5.4 JBOD/RAID Function	81
3.7.5.5 Background Task Priority	82
3.7.5.6 SATA NCQ Support	82
3.7.5.7 HDD Read Ahead Cache	83
3.7.5.8 Volume Data Read Ahead	84
3.7.5.9 Hdd Queue Depth Setting	84
3.7.5.10 Empty HDD Slot LED	85
3.7.5.11 Controller Fan Detection	86
3.7.5.12 Auto Activate Raid Set	86
3.7.5.13 Disk Write Cache Mode	87
3.7.5.14 Write Same Support	87
3.7.5.15 Capacity Truncation	88
3.7.6 More System Functions	89
3.7.6.1 Smart Option For HDD	89
3.7.6.2 Smart Polling Interval	90

3.7.6.3 Hot Plugged Disk For Rebuilding	91
3.7.7 HDD Power Management	92
3.7.7.1 Stagger Power On.....	92
3.7.7.2 Time To Hdd Low Power Idle	93
3.7.7.3 Time To Low RPM Mode	94
3.7.7.4 Time To Spin Down Idle Hdd	94
3.7.8 Ethernet Configuration	95
3.7.8.1 DHCP Function	95
3.7.8.2 Local IP address	96
3.7.8.3 HTTP Port Number	97
3.7.8.4 Telnet Port Number	97
3.7.8.5 SMTP Port Number.....	98
3.7.8.6 Ethernet Address.....	98
3.7.9 Alert By Mail Config	99
3.7.10 View System Events.....	99
3.7.11 Clear Events Buffer	100
3.7.12 Hardware Monitor	100
3.7.13 System Information	101
4. Driver Installation	102
4.1 Creating the Driver Diskettes	102
4.2 Driver Installation for Windows	104
4.2.1 Installing Windows on a RAID Volume	104
4.2.2 Installing Controller on an Existing Windows	105
4.2.3 Uninstall controller from Windows	107
4.3 Driver Installation for Linux	107
4.4 Driver Installation for FreeBSD.....	108
4.5 Driver Installation for Solaris	109
4.6 Driver Installation for Mac OS X	109
4.6.1 Installation Procedures.....	109
4.6.2 Making Volume Sets Available to Mac OS X	112
5. ArchHTTP Proxy Server Installation	114
5.1 For Windows.....	115
5.2 For Linux	116
5.3 For FreeBSD.....	118
5.4 For Solaris 10	118
5.5 For Mac OS X.....	119
5.6 ArchHTTP Configuration	119
6. Web Browser-based Configuration	124
6.1 Start-up McRAID Storage Manager	124
• Start-up from Windows/Mac Local Administration	125
• Start-up from Local Administration	125

• Start-up from Ethernet Port (Out-of-Band)	126
6.2 McRAID Storage Manager	127
6.3 Main Menu	128
6.4 Quick Function	128
6.5.1 Create Raid Set	129
6.5.2 Delete Raid Set	130
6.5.3 Expand Raid Set	130
6.5.4 Offline Raid Set	131
6.5.5 Rename Raid Set	132
6.5.6 Activate Incomplete Raid Set	132
6.5.7 Create Hot Spare	133
6.5.8 Delete Hot Spare	134
6.5.9 Rescue Raid Set	134
6.6 Volume Set Functions	135
6.6.1 Create Volume Set (0/1/10/3/5/6)	135
6.6.2 Create Raid30/50/60 (Volume Set 30/50/60)	140
6.6.3 Delete Volume Set	141
6.6.4 Modify Volume Set	141
6.6.4.1 Volume Growth	142
6.6.4.2 Volume Set Migration	143
6.6.4.3 Volume Write Protection	143
6.6.5 Check Volume Set	144
6.6.6 Schedule Volume Check	144
6.6.7 Stop Volume Set Check	145
6.6.8 Download Volume Key File	145
6.7 Security Function	146
6.7.1 Create SED RAID Set	146
6.7.2 Delete SED RAID Set	147
6.7.3 Delete ISE RAID Set	147
6.7.4 Security Key Setup	148
6.7.4.1 SED Key Management-Creation	148
6.7.4.2 SED Key Management-Modification	149
6.7.5 Import Security Key	150
6.7.6 Erase Failed Disk	151
6.7.7 RevertSP	151
6.8 Physical Drive	152
6.8.1 Create Pass-Through Disk	152
6.8.2 Modify Pass-Through Disk	152
6.8.3 Delete Pass-Through Disk	153
6.8.4 Clone Disk	154
6.8.4.1 Clone And Replace	155

6.8.4.2 Clone Only	155
6.8.5 Abort Cloning.....	155
6.8.6 Set Disk To Be Failed	155
6.8.7 Activate Failed Disk	156
6.8.8 Identify Enclosure	156
6.8.9 Identify Drive	157
6.9 System Controls	158
6.9.1 System Config	158
• System Beeper Setting	158
• Background Task Priority	158
• JBOD/RAID Configuration	158
• SATA NCQ Support	159
• HDD Read Ahead Cache	159
• Volume Data Read Ahead	159
• HDD Queue Depth	159
• Empty HDD Slot LED	159
• CPU Fan Detection.....	160
• SES2 Support	160
• Max Command Length	160
• Auto Activate Incomplete Raid	160
• Disk Write Cache Mode	160
• Write Same For Initialization	161
• Hot Plugged Disk For Rebuilding	161
• PCIE Gen3	161
• Disk Capacity Truncation Mode.....	161
• Smart Option For HDD	162
• Smart Polling Interval	162
6.9.2 Advanced Configuration.....	163
• TLER Setting	163
• Timeout Setting	164
• Number of Retries	164
• Buffer Threshold	164
• Amount of Read Ahead	164
• Number of AV Stream.....	165
• Optimize AV Recording.....	165
• Read Performance Margin.....	166
• Write Performance Margin	166
• Read And Discard Parity Data	168
• Fail Disk For Any Timeout.....	168
• Hitachi/WDC/Seagate SATA HDD Speed	168
• BIOS Selection.....	168

• PCIE Link Down Reset.....	168
• Active Cable Management	169
• Host Command Queue Mode.....	169
• End Device Frame Buffering.....	169
• Write Cache Amount.....	169
• Dual Path Usage	170
• Ext Connector#1 Speed Limit	171
• Ext Connector#2 Speed Limit	171
6.9.3 HDD Power Management.....	171
6.9.3.1 Stagger Power On Control.....	171
6.9.3.2 Time To Hdd Low Power Idle	172
6.9.3.3 Time To Hdd Low RPM Mode	172
6.9.3.4 Time To Spin Down Idle HDD.....	172
6.9.3.5 SATA Power Up In Standby	172
6.9.4 Ethernet Configuration	173
6.9.5 Alert By Mail Configuration	174
6.9.6 SNMP Configuration	175
6.9.7 NTP Configuration	175
6.9.8 View Events/Mute Beeper	176
6.9.9 Generate Test Event	177
6.9.10 Clear Events Buffer.....	177
6.9.11 Modify Password.....	177
6.9.12 Update Firmware	178
6.10 Information	179
6.10.1 Raid Set Hierarchy.....	179
6.10.1.1 Hdd Xfer Speed	179
6.10.2 SAS Chip Information.....	180
6.10.3 System Information	181
6.10.4 Hardware Monitor	181
Appendix A	182
Upgrading Flash ROM Update Process.....	182
Appendix B.....	186
Flash-based Backup Module (ARC-1883-BAT/CAP).....	186
Appendix C.....	191
Battery Backup Module (ARC-6120BA-T121-12G).....	191
Appendix D.....	195
SNMP Operation & Installation.....	195
Appendix E	206
Event Notification Configurations	206
A. Device Event.....	206
B. Volume Event.....	207

C. RAID Set Event	207
D. Hardware Monitor Event	208
Appendix F	209
Self-Encrypting Disk (SED) Encryption.....	209
Appendix G.....	215
Full Volume Encryption	215
Appendix H.....	220
RAID Concept	220
RAID Set.....	220
Volume Set.....	220
Ease of Use Features.....	221
• Foreground Availability/Background Initialization	221
• Online Array Roaming	221
• Online Capacity Expansion.....	221
• Online Volume Expansion	224
High availability.....	224
• Global/Local Hot Spares.....	224
• Hot-Swap Disk Drive Support.....	225
• Auto Declare Hot-Spare	225
• Auto Rebuilding	226
• Adjustable Rebuild Priority.....	226
High Reliability	227
• Hard Drive Failure Prediction.....	227
• Auto Reassign Sector.....	227
• Consistency Check	228
Data Protection	229
• Battery Backup	229
• Recovery ROM	229
Appendix I.....	230
Understanding RAID	230
RAID 0	230
RAID 1 - Simple Mirroring.....	231
RAID 1 - Multi Mirroring.....	232
RAID 10(1E)	233
RAID 3.....	233
RAID 5.....	234
RAID 6.....	235
RAID x0	235
JBOD	236
Single Disk (Mirrored Pass-Through Disk).....	236

INTRODUCTION

1. Introduction

This section presents a brief overview of the 12Gb/s SAS RAID controller, ARC-1883 series. (PCIe 3.0 to 12Gb/s SAS RAID controllers)

1.1 Overview

The 12Gb/s SAS interface supports both 12Gb/s SAS disk drives for data-intensive applications and 6Gb/s SATA drives for low-cost bulk storage of reference data. The ARC-1883 family includes 8 ports low profile as well as 12/16/24 internal ports with additional 4 external ports models. The ARC-1883LP/1883i/1883x support eight 12Gb/s SAS ports via one internal & one external/two internal/two external Mini SAS HD connector. The ARC-1883ix-12/16/24 attaches directly to SATA/SAS midplanes with 3/4/6 Mini SAS HD SFF-8643 internal connector or increase capacity using one additional Mini SAS HD SFF-8644 external connector. When used with 12Gb/s SAS expanders, the controller can provide up to (256) devices through one or more 12Gb/s SAS JBODs, making it an ideal solution for enterprise-class storage applications that called for maximum configuration flexibility.

ARC-1883i/LP/x 12Gb/s RAID controllers are low-profile PCIe cards, ideal for 1U and 2U rack-mount systems. These controllers utilize the same RAID kernel that has been field-proven in existing external RAID controller products, allowing Areca to quickly bring stable and reliable PCIe 3.0 12Gb/s SAS RAID controllers to the market.

Unparalleled Performance for 12Gb/s SAS

The 12Gb/s SAS RAID controllers raise the standard to higher performance levels with several enhancements including new high performance 1.2 GHz dual core ROC processor, a DDR3-1866 memory architecture and high performance PCIe 3.0 interface bus interconnection. The low profile controllers by default support on-board 2G of ECC DDR3-1866 SDRAM memory. ARC-1883ix-12/16/24 RAID controllers each include one 240-pin DIMM socket with default 2GB DDR3-1866, single rank, 1Rx8, upgrade to 8GB or 8GB DDR3-1600, dual rank, 2Rx8, ECC SDRAM. The 12Gb/s SAS is designed for backward compatibility with 6Gb/s and 3Gb/s SAS/SATA hard

INTRODUCTION

drives. Regardless of the drive speed, 12Gb/s SAS RAID controllers will provide maximum read/write performance improvements for the most performance-hungry database and IT applications.

The ARC-1883ix includes one 12Gb/s SAS expander that incorporates the latest enhancements in SAS along with new LSI DataBolt bandwidth optimizer technology. This is designed to help facilitate the industry transition to 12Gb/s SAS-enabled systems by allowing users to take advantage of 12Gb/s speeds while utilizing existing 6Gb/s drives and backplanes. Using DataBolt, the ARC-1883ix buffers 6Gb/s data and then transfers it out to the host at 12Gb/s speeds in order to match the bandwidth between faster hosts and slower SAS or SATA devices

Unsurpassed Data Availability

Designed and leveraged with Areca's existing high performance RAID solution, ARC-1883 provides superior levels performance and enterprise level data protection for the most demanding next-generation server and storage environments. It supports the hardware RAID 6 engine to allow two HDDs failures without impact the existing data and performance. It allows users to hot swap drive in the event of a drive failure with zero downtime. The optional flash-based backup module provides power to transfer the cache data from the SDRAM memory to the NAND flash memory if it contains data not yet written to the drives when power is lost. ARC-1883 also supports traditional Lithium-ion (Li-ion) battery backup module (BBM) to protect cached data on RAID adapters. Board-level hardware encryption manages any kinds of drives attached to ARC-1883 controller cards for higher levels of security. API code supports for third-party Enterprise Key Management systems to easy integrate and manage encryption function.

Maximum Interoperability

The 12Gb/s SAS RAID controller support broad operating system including Windows, Linux (Open Source), FreeBSD (Open Source), Solaris (Open Source), Mac, VMware and more, along with key system monitoring features such as enclosure management (SES-2, SMP, & SGPIO) and SNMP function. Our products and technology are based on extensive testing and validation process; leverage

INTRODUCTION

ARC-1880/1882 series controller field-proven compatibility with operating systems, motherboards, applications and device drivers.

Easy RAID Management

The controllers contain an embedded McBIOS RAID manager that can access via hot key at M/B BIOS boot-up screen. This pre-boot McBIOS RAID manager can use to simplify the setup and management of RAID controller. The controller firmware also contains a browser-based McRAID storage manager which can be accessed through the Ethernet port or ArchHTTP proxy server in Windows, Linux, FreeBSD and more environments. The McRAID storage manager allows local and remote for all storage configuration and management needs from standard web browser. The ArcSAP quick manager can scan for multiple RAID units in the local and remote systems and provide an effective mechanism to configure and monitor your RAID units.

1.2 Features

Controller Architecture

- Dual core RAID-on-Chip (ROC) 1.2GHz processor
- PCIe 3.0 x8 lane host interface
- 2GB on-board DDR3-1866 SDRAM with ECC (ARC-1883i/LP/x)
- One 240-pin DIMM socket for 2GB(default) DDR3-1866, 1RX8, ECC module (ARC-1883ix-12/16/24)
 - up to 4GB or 8GB DDR3-1866, 1RX8, Unbuffered/Registered ECC module or
 - up to 4GB or 8GB DDR3-1600, 2RX8, Unbuffered/Registered ECC module
- Write-through or write-back cache support
- Support up to 4/8/12/16/24 internal or 4/8 external 12Gb/s SAS ports
- Multi-adapter support for large storage requirements
- BIOS boot array support for greater fault tolerance
- Supports up to 256 SATA or SAS devices using SAS expanders
- Boot support for the uEFI host BIOS
- DataBolt™ Bandwidth Optimizer for balance faster host and slower SAS or SATA devices. (for ARC-1883ix)
- Redundant flash image for controller availability

INTRODUCTION

- Support flash-based or battery backup module (FBM/BBM) ready (optional)
- RoHS compliant

RAID Features

- RAID level 0, 1, 10(1E), 3, 5, 6, 30, 50, 60, Single Disk or JBOD
- Multiple RAID 0 and RAID 10(1E) support (RAID 00 and RAID100)
- Multiple RAID selection
- Configurable stripe size up to 1024KB
- Support HDD firmware update
- Online array roaming
- Online RAID level/stripe size migration
- Online capacity expansion and RAID level migration simultaneously
- Online volume set growth
- Instant availability and background initialization
- Support global and dedicated hot spare
- Automatic drive insertion/removal detection and rebuilding
- Support for native 4K and 512 byte sector SAS and SATA devices
- Multiple pairs SSD/HDD disk clone function
- SSD automatic monitor clone (AMC) support
- Controller level hardware encryption support
- Support intelligent power management to save energy and extend service life

Monitors/Notification

- System status indication through global HDD activity/fault connector, individual activity/fault connector, LCD/I²C connector and alarm buzzer
- SMTP support for email notification
- SNMP support for remote manager
- Enclosure management (SES-2, SMP and SGPIO) ready

RAID Management

- Field-upgradeable firmware in flash ROM

In-Band Manager

- Hot key "boot-up" McBIOS RAID manager via M/B BIOS
- Web browser-based McRAID storage manager via ArchHTTP proxy server for all operating systems
- Support Command Line Interface (CLI)

INTRODUCTION

- API library for customer to write manager utility
- Single Admin Portal (ArcSAP) quick manager utility

Out-of-Band Manager

- Firmware-embedded web browser-based McRAID storage manager, SMTP manager, SNMP agent and Telnet function via Ethernet port
- API library for customer to write manager utility
- Support push button and LCD display panel (optional)

Operating System

- Windows 10/8/Server 2012/7/2008/Vista/XP/2003
- Linux
- FreeBSD
- VMware (Driver 6.x support CLI in-band management utility)
- Solaris 10/11 x86/x86_64
- Mac OS X 10.4.x or higher

(For latest supported OS listing visit <http://www.areca.com.tw>)

12Gb/s SAS RAID Controllers			
Model Name	ARC-1883i	ARC-1883LP	ARC-1883x
I/O Processor	Dual Core RAID-on-Chip 1.2GHz		
Form Factor (H x L)	Low Profile: 64.4 x 169.5 mm		
Host Bus Type	PCIe 3.0 x 8 Lanes		
Driver Connector	2xSFF-8643	1xSFF-8643 1xSFF-8644	2xSFF-8644
Drive Support	Up to 256 12Gb/s SAS or 6Gb/s and 3Gb/s SAS/SATA HDDs		
FBM/BBM Support	ARC-1883-CAP / ARC-1883-BAT / ARC-6120BA-T121-12G		
RAID Level	0, 1, 1E, 3, 5, 6, 10, 30, 50, 60, Single Disk, JBOD		
On-Board Cache	2GB on-board DDR3-1866 SDRAM		
Management Port	In-Band: PCIe Out-of-Band: BIOS, LCD, LAN Port		
Enclosure Ready	Individual Activity/Faulty Header, SGPIO, SMP, SES-2		

INTRODUCTION

12Gb/s SAS RAID Controllers			
Model Name	ARC-1883ix-12	ARC-1883ix-16	ARC-1883ix-24
I/O Processor	Dual Core RAID-on-Chip 1.2GHz		
Form Factor (H x L)	Full Height: 98.4 x 254 mm		
Host Bus Type	PCIe 3.0 x 8 Lanes		
Driver Connector	3xSFF-8643 1xSFF-8644	4xSFF-8643 1xSFF-8644	6xSFF-8643 1xSFF-8644
Drive Support	Up to 256 12Gb/s SAS or 6Gb/s and 3Gb/s SAS/SATA HDDs		
FBM/BBM Support	ARC-1883-CAP (support cache 2GB)/ ARC-1883-BAT (support cache 2GB, 4GB or 8GB)/ ARC-6120BA-T121-12G		
RAID Level	0, 1, 1E, 3, 5, 6, 10, 30, 50, 60, Single Disk, JBOD		
On-Board Cache	One 240-pin DIMM socket for 2GB(default) DDR3-1866, 1RX8, ECC module - up to 4GB or 8GB DDR3-1866, 1RX8, Unbuffered/Registered ECC module or - up to 4GB or 8GB DDR3-1600, 2RX8, Unbuffered/Registered ECC module		
Management Port	In-Band: PCIe Out-of-Band: BIOS, LCD, LAN Port		
Enclosure Ready	Individual Activity/Faulty Header, SGPIO, SMP, SES-2		

HARDWARE INSTALLATION

2. Hardware Installation

This section describes the procedures for installing the 12Gb/s SAS RAID controllers.

2.1 Before You First Installing

Thanks for purchasing the 12Gb/s SAS RAID controller as your RAID data storage subsystem. This user manual gives simple step-by-step instructions for installing and configuring the 12Gb/s SAS RAID controller. To ensure personal safety and to protect your equipment and data, reading the following information package list carefully before you begin installing.

Package Contents

If your package is missing any of the items listed below, contact your local dealers before you install. **(Disk drives and disk mounting brackets are not included)**

- 1 x 12Gb/s SAS RAID controller in an ESD-protective bag
- 1 x Installation CD – containing driver, relative software, an electronic version of this manual and other related manual
- 1 x User manual
- Adapter convert two 4 pin peripheral power cables into a PCI-E power cable (ARC-1883ix only)
- 1 x Low-profile bracket

Note:

Low-profile bracket has included on the low profile board shipping package.

2.2 Board Layout

The controller can support a family included 8 ports models as well as industry-first 8/12/16/24 internal ports with additional 4 external ports. This section provides the board layout and connector/jumper for the 12Gb/s SAS RAID controller.

HARDWARE INSTALLATION

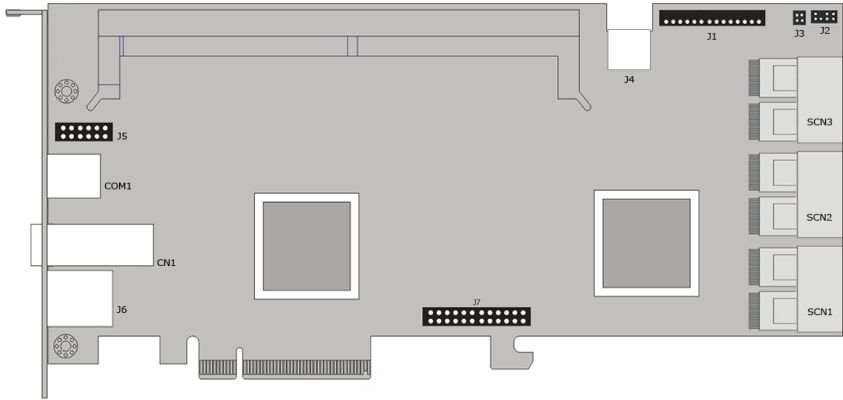

Figure 2-1, ARC-1883ix-12/16/24 Top View

Connector	Type	Description
1. (J1)	Flash-based/Battery Backup Module Connector	14-pin box header
2. (J2)	I ² C/LCD Connector	7-pin header
3. (J3)	Global Fault/Activity LED	4-pin header
4. (J4)	PCI-E Power Connector	6-pin header
5. (J5)	Manufacture Purpose Port	12-pin header
6. (J6)	Ethernet Port	RJ45
7. (J7)	Individual Fault LED Header	24-pin header
8. (COM1)	RS232 Port for CLI to configure the expander functions on the RAID controller (*1)	RJ11 connector
9. (CN1)	Mini SAS HD 25-28 Ports (External)	SFF-8644
10. (SCN1)	Mini SAS HD 1-8 Ports (Internal)	SFF-8643
11. (SCN2)	Mini SAS HD 9-16 Ports (Internal)	SFF-8643
12. (SCN3)	Mini SAS HD 17-24 Ports (Internal)	SFF-8643

Table 2-1, ARC-1883ix-12/16/24 Connectors

Note:

You can download the ARC1882ix_1883ix Expander-CLI.PDF manual from "<http://www.areca.com.tw/support/main.htm>" to view and set expander configuration.

HARDWARE INSTALLATION

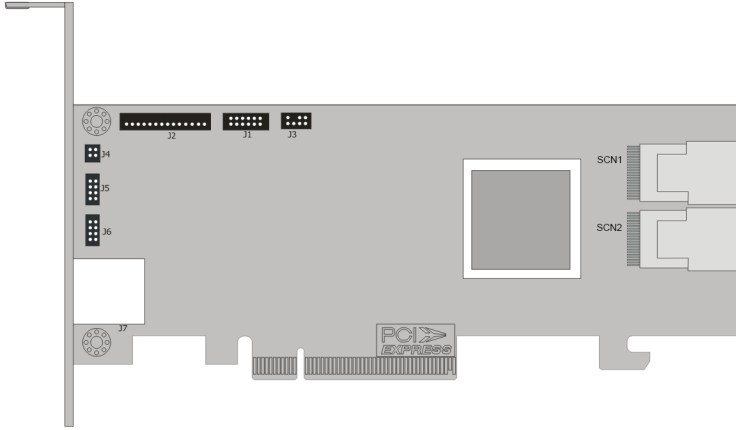

Figure 2-2, ARC-1883i Top View

Connector	Type	Description
1. (J1)	Manufacture Purpose Port	12-pin header
2. (J2)	Flash-based/Battery Backup Module Connector	14-pin box header
3. (J3)	I ² C/LCD Connector	7-pin header
4. (J4)	Global Fault/Activity LED	4-pin header
5. (J5)	Individual Activity (HDD) LED Header	4-pin header
6. (J6)	Individual Fault LED Header	4-pin header
7. (J7)	Ethernet Port	RJ45
8. (SCN1)	Mini SAS HD 1-4 Ports (Internal)	SFF-8643
9. (SCN2)	Mini SAS HD 5-8 Ports (Internal)	SFF-8643

Table 2-2, ARC-1883i Connectors

HARDWARE INSTALLATION

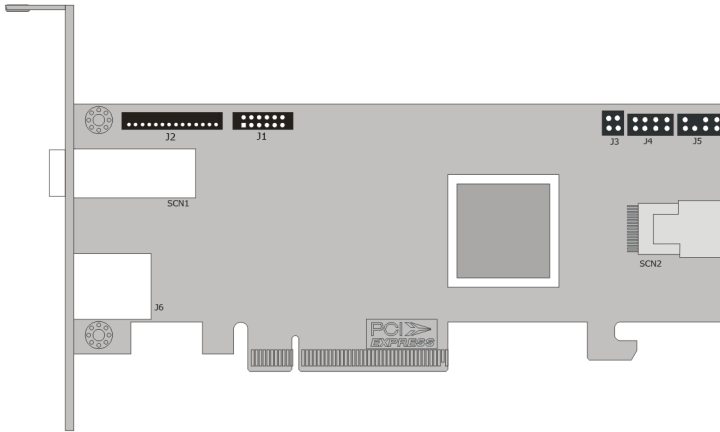

Figure 2-3, ARC-1883LP Top View

Connector	Type	Description
1. (J1)	Manufacture Purpose Port	12-pin box header
2. (J2)	Flash-based/Battery Backup Module Connector	14-pin header
3. (J3)	Global Fault/Activity LED	4-pin header
4. (J4)	Individual Fault/Activity LED Header	8-pin header
5. (J5)	I ² C/LCD Connector	7-pin header
6. (SCN1)	Mini SAS HD 5-8 Ports (External)	SFF-8644
7. (SCN2)	Mini SAS HD 1-4 Ports (Internal)	SFF-8643
8. (J6)	Ethernet Port	RJ45

Table 2-3, ARC-1883LP Connectors

HARDWARE INSTALLATION

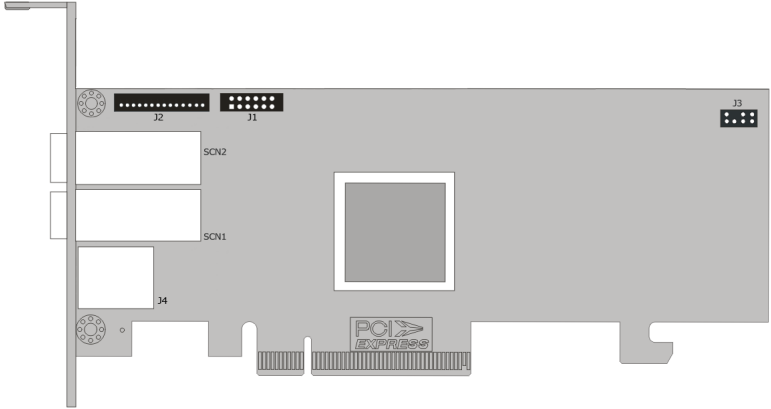
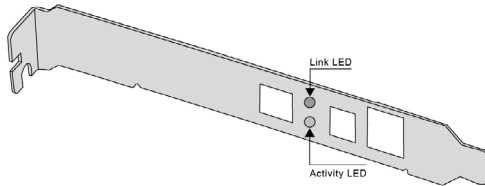

Figure 2-4, ARC-1883x Top View

Connector	Type	Description
1. (J1)	Manufacture Purpose Port	12-pin header
2. (J2)	Flash-based/Battery Backup Module Connector	14-pin box header
3. (J3)	I ² C/LCD Connector	7-pin header
4. (J4)	Ethernet Port	RJ45
5. (SCN1)	Mini SAS HD 5-8 Ports (External)	SFF-8644
6. (SCN2)	Mini SAS HD 1-4 Ports (External)	SFF-8644

Table 2-4, ARC-1883x Connectors

The following table describes the ARC-1883ix external port Mini SAS HD SFF-8644 link/activity LED behavior.



LED	Status
Link LED (Green light)	When the link LED is lit that indicates the link LED is connected.
Activity LED (Blue light)	The activity LED is lit that indicates the adapter is active.

HARDWARE INSTALLATION

Tools Required

An ESD grounding strap or mat is required. Also required are standard hand tools to open your system's case.

System Requirement

The 12Gb/s SAS RAID controller can be installed in an universal PCIe slot and requires a motherboard that:

ARC-1883 series 12Gb/s SAS RAID controller requires:

- Comply with the PCIe 3.0 x8 lanes
It can work on the PCIe 3.0 x1, x4, x8, and x16 signal with x8 or x16 mechanical slot M/B.
- Backward-compatible with PCIe 1.0/2.0

Installation Tools

The following items may be needed to assist with installing the 12Gb/s SAS RAID controller into an available PCIe expansion slot.

- Small screwdriver
- Host system hardware manuals and manuals for the disk or enclosure being installed

Personal Safety Instructions

Use the following safety instructions to help you protect your computer system from potential damage and to ensure your own personal safety.

- Always wear a grounding strap or work on an ESD-protective mat.
- Before opening the system cover, turn off power switches and unplug the power cords. Do not reconnect the power cords until you have replaced the covers.

Electrostatic Discharge

Static electricity can cause serious damage to the electronic components on this 12Gb/s SAS RAID controller. To avoid damage

HARDWARE INSTALLATION

caused by electrostatic discharge, observe the following precautions:

- Do not remove the 12Gb/s SAS RAID controller from its anti-static packaging until you are ready to install it into a computer case.
- Handle the 12Gb/s SAS RAID controller by its edges or by the metal mounting brackets at its each end.
- Before you handle the 12Gb/s SAS RAID controller in any way, touch a grounded, anti-static surface, such as an unpainted portion of the system chassis, for a few seconds to discharge any built-up static electricity.

Warning:

High voltages may be found inside computer equipment. Before installing any of the hardware in this package or removing the protective covers of any computer equipment, turn off power switches and disconnect power cords. Do not reconnect the power cords until you have replaced the covers.

2.3 Installation

Use the instructions below to install a 12Gb/s SAS RAID controller.

Step 1. Unpack

Unpack and remove the 12Gb/s SAS RAID controller from the package. Inspect it carefully, if anything is missing or damaged, contact your local dealer.

Step 2. Power PC/Server Off

Turn off computer and remove the AC power cord. Remove the system's cover. For the instructions, please see the computer system documentation.

Step 3. Check Memory Module (ARC-1883ix only)

Be sure of the cache memory module is present and seated firmly in the 240-pin DIMM socket for ARC1883ix-12/16/24 models. The

HARDWARE INSTALLATION

physical memory configuration for ARC-1883ix series is one 240-pin DIMM socket for 2GB(default) up to 8GB DDR3-1866, 1Rx8, ECC module or 8GB, DDR3-1600, 2Rx8, ECC module.

Step 4. Install the 12Gb/s SAS RAID Controllers

To install the 12Gb/s SAS RAID controller, remove the mounting screw and existing bracket from the rear panel behind the selected PCIe 3.0 slot. Align the gold-fingered edge on the card with the selected PCIe 3.0 slot. Press down gently but firmly to ensure that the card is properly seated in the slot, as shown in Figure 2-5. Then, screw the bracket into the computer chassis. ARC-1883 series controllers require a PCIe 3.0 x8 slot for better performance.

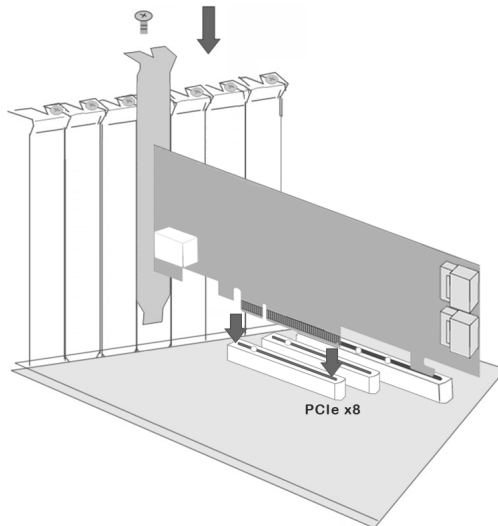

Figure 2-5, Insert into a PCIe Slot

Step 5. Mount the Drives

You can connect the SAS/SATA drives to the controller through direct cable and backplane solutions. In the direct connection, SAS/SATA drives are directly connected to 12Gb/s SAS RAID controller PHY port with SAS/SATA cables. The 12Gb/s SAS RAID controller can support up to 28 PHY ports. Remove the front bezel from the computer chassis and install the cages or SAS/SATA drives in the computer chassis. Loading drives to the drive tray if cages are

HARDWARE INSTALLATION

installed. Be sure that the power is connected to either the cage backplane or the individual drives.

In the backplane solution, SAS/SATA drives are directly connected to 12Gb/s SAS system backplane or through an expander board. The number of SAS/SATA drives is limited to the number of slots available on the backplane. Some backplanes support daisy chain expansion to the next backplanes. The 12Gb/s SAS RAID controller can support daisy-chain up to 8 enclosures. The maximum drive no. is 256 devices through 8 enclosures. The following figure shows how to connect the external Mini SAS HD SFF-8644 cable from the 12Gb/s SAS RAID controller that has external connectors to the external drive boxes or drive enclosures.

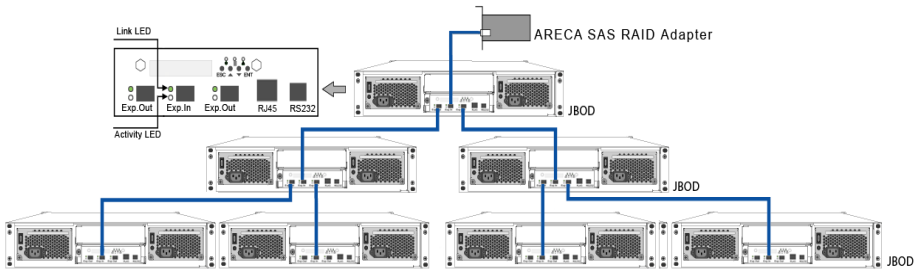

Figure 2-6, Connecting to Drive Enclosure

The following table shows the maximum number of 12Gb/s SAS RAID controller supported:

	Disks/Enclosure	Expander	Disks/Controller	Volume
Max No.	128	12	256	128

Note:

The maximum no. is 32 disk drives included in a single RAID set.

HARDWARE INSTALLATION

Step 6. Install SAS Cable

This section describes how to cable a controller to the drive or backplane.

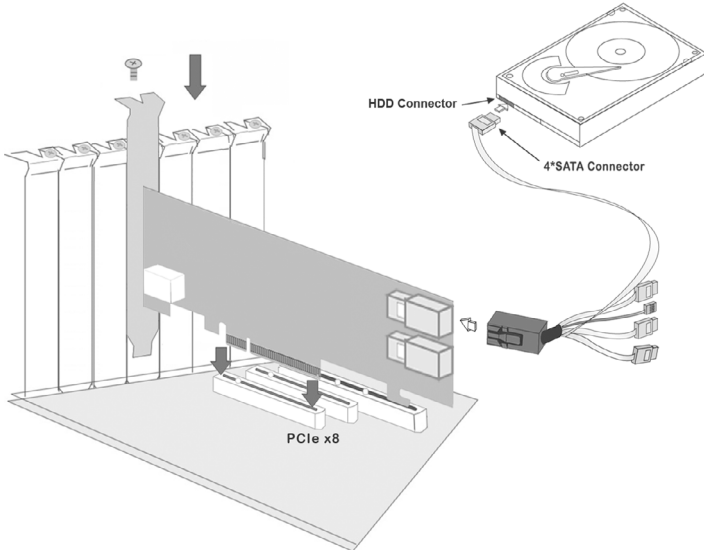

Figure 2-7, Connecting to HDD

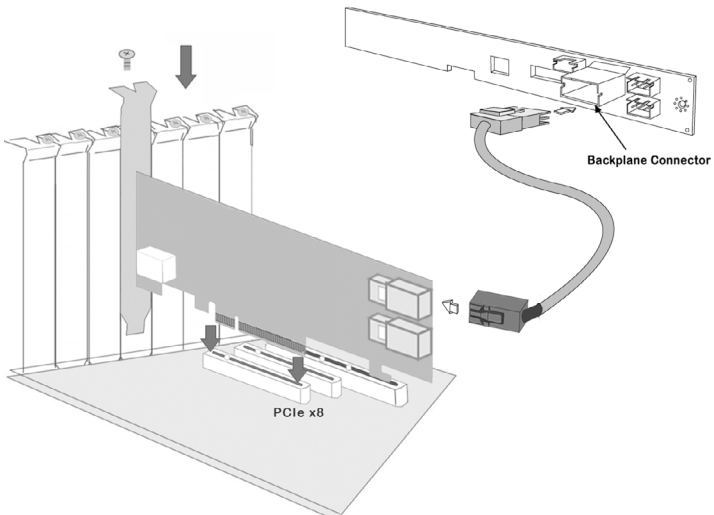

Figure 2-8, Connecting to Backplane

HARDWARE INSTALLATION

Step 7. Connect Power to the Controller (ARC-1883ix only)

There is a 6-pin PCI-E connector on the ARC-1883ix labelled J4. You must plug in a PSU's PCI-E cable at all times to supply enough stable power for the controller.

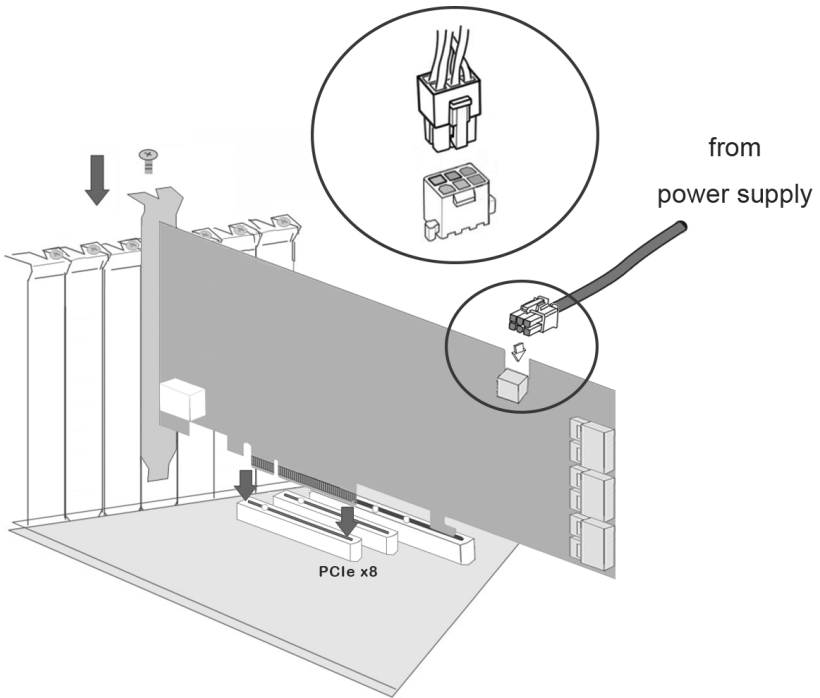

Figure 2-9, Connect Direct from Power Supply

If your power supply doesn't have a 6 pin PCI-E power cable then you can use the adapter to convert two 4 pin peripheral power cables into a PCI-E power cable. If you use an adapter then be sure to plug the 4 pin peripheral power connectors into separate power cables coming from the power supply.

HARDWARE INSTALLATION

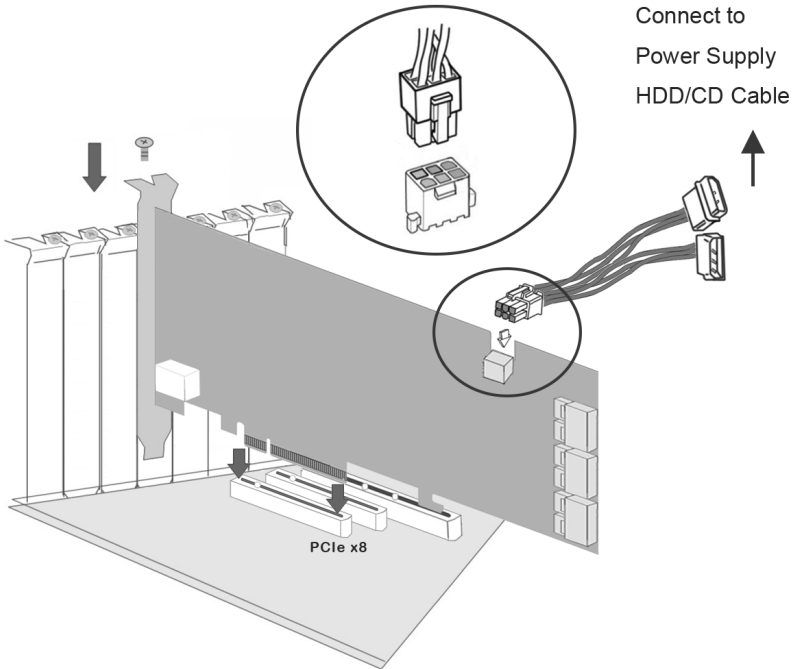

Figure 2-10, Connect through HDD/CD Cable

Step 8. Install the LED Cable (Optional)

The preferred I/O connector for server backplanes is the Mini SAS HD SFF-8643 connector. This connector has eight signal pins to support four SAS/SATA drives and six pins for the SGPIO (Serial General Purpose Input/Output) side-band signals. The SGPIO bus is used for efficient LED management and sensing drive locate status. See SFF 8485 for the specification of the SGPIO bus. For backplane without enclosure SGPIO support, please refer to section 2.5 LED cables for fault/activity LED cable installation.

LED Management: The backplane may contain LEDs to indicate drive status. Light from the LEDs could be transmitted to the outside of server by using light pipes mounted on the SAS drive tray. A small microcontroller on the backplane, connected via the SGPIO bus to a 12Gb/s SAS RAID controller, could control the LEDs. Activity: blinking 5 times/second and Fault: lit

HARDWARE INSTALLATION

Drive Locate: The location of a drive may be detected by sensing the voltage level of one of the pre-charge pins before and after a drive is installed.

The following signals define the SGPIO assignments for the Mini SAS HD SFF-8643 in the 12Gb/s SAS RAID controller.

Pin	Description	Pin	Description
SideBand0	SClock (Clock signal)	SideBand1	SLoad (Last clock of a bit stream)
SideBand2	Ground	SideBand3	Ground
SideBand4	SDataOut (Serial data output bit stream)	SideBand5	SDataIn (Serial data input bit stream)
SideBand6	Reserved	SideBand7	Reserved

The Mini SAS HD SFF-8643 to 4xSATA with sideband cable follows the SFF-8448 specification. The SFF-8448 sideband signals cable is reserved for the backplane with header on it. The following signal defines the sideband connector which can work with Areca sideband cable on its Mini SAS HD SFF-8643 to 4xSATA cable.

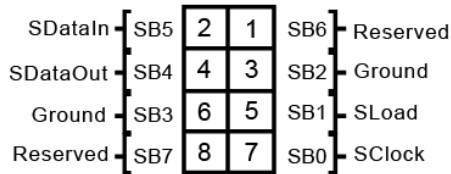

Sideband Pin Definitions

The sideband header is located at backplane. For SGPIO to work properly, please connect the 8-pin sideband cable to the sideband header as shown above.

Step 9. Adding a FBM/BBM Backup Module (Optional)

Please refer to Appendix B and Appendix C of the user manual for installing the flash-based/battery backup module (FBM/BBM) in your 12Gb/s SAS RAID controller.

Step 10. Re-check Fault LED Cable Connections (Optional)

Be sure that the proper failed drive channel information is displayed by the fault LEDs. An improper connection will light the

HARDWARE INSTALLATION

wrong LED which causes the user to hot swap the wrong drive. This could result in failure and loss of system data.

Step 11. Power up the System

Thoroughly check the installation, reinstall the computer cover, and reconnect the power cord cables. Turn on the power switch at the rear of the computer (if equipped) and then press the power button at the front of the host computer.

Step 12. Install the Controller Driver

For a new system:

- Driver installation usually takes place as part of operating system installation. Please refer to Chapter 4 "Driver Installation" of the user manual for the detailed installation procedure.

In an existing system:

- To install the controller driver into the existing operating system. For the detailed installation procedure, please refer to the Chapter 4 "Driver Installation" of the user manual.

Step 13. Install ArcHTTP Proxy Server

The 12Gb/s SAS RAID controller firmware has embedded the web-browser McRAID storage manager. ArcHTTP proxy server will launch the web-browser McRAID storage manager. It provides all of the creation, management and monitor 12Gb/s SAS RAID controller status. Please refer to the Chapter 5 of the user manual for the detail ArcHTTP Proxy Server Installation. For SNMP agent function, please refer to Appendix D of the user manual.

Step 14. Configure Volume Set

The controller configures RAID functionality through the McBIOS RAID manager. Please refer to Chapter 3 of the user manual, McBIOS RAID Manager, for the detail. The RAID controller can also be configured through the McRAID storage manager with ArcHTTP proxy server installed or through on-board LAN port and LCD module (refer to LCD manual). For McRAID storage manager option, please refer to Chapter 6 of the user manual, Web Browser-Based Configuration.

HARDWARE INSTALLATION

Step 15. Determining the Boot Sequences

For PC system:

12Gb/s SAS RAID controller is a bootable controller. If your system already contains a bootable device with an installed operating system, you can set up your system to boot a second operating system from the new controller. To add a second bootable controller, you may need to enter setup of motherboard BIOS and change the device boot sequence so that the new RAID controller heads the list. If the system BIOS setup does not allow this change, your system may be not configurable to allow the 12Gb/s SAS RAID controller to act as a second boot device.

For Intel-based Mac system:

Areca controller has supported the EFI BIOS on the PCIe 3.0 12Gb/s SAS RAID controller. You have other alternatively to add volumes on the Intel-based Mac bootable device listing. You can follow the following procedures to add 12Gb/s SAS RAID controller on the Mac bootable device listing.

1. Set the BIOS selection in System Controls: Advance Configuration to "EFI" option for Intel-based MacPro boot.
2. Download OS X Mavericks and DiskMaker X. Follow the DiskMaker X to make a bootable OS X Mavericks USB install drive.
3. Restart your Mac and after you hear the chime sound, press the Option (Alt) key until you see the option to choose the flash drive to boot from.
4. Follow the on-screen prompts to complete Areca Volume Upgrade and Clean Install of OS X Mavericks. Power up the Intel-based Mac and Areca volume will be added in the bootable device automatically.

HARDWARE INSTALLATION

2.4 SAS Cables

You can connect the end devices to each other through direct cables or through the SAS expander/backplane connections. The 12Gb/s SAS RAID controller supports daisy-chain expansion up to 8 enclosures. The following is an example of some internal SAS/SATA cables and an external SAS cable.

2.4.1 Mini SAS HD SFF-8643 to 4xSATA Cable

The Mini SAS HD SFF-8643 to 4xSATA cables are used for connection between the 12Gb/s SAS RAID controller internal connectors and connectors on the SAS/SATA disk drives or SAS/SATA connector backplane. The 12Gb/s SAS controllers have 1-6 Mini SAS HD SFF-8643 internal connectors, each of them can support up to four SAS/SATA drives.

These controllers can be installed in a server RAID enclosure with standard SATA connectors backplane. The following diagram shows the picture of Mini SAS HD SFF-8643 to 4xSATA cables. Backplane with SGPIO header can leverage the SGPIO function on the 12Gb/s SAS RAID controller through the sideband cable.

The SFF-8448 sideband signals cable is reserved for the backplane with header on it.

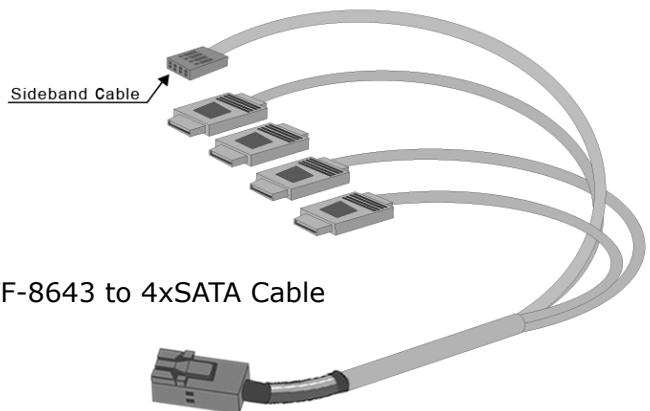

Figure 2-11, SFF-8643 to 4xSATA Cable

HARDWARE INSTALLATION

2.4.2 Mini SAS HD SFF-8643 to 4xSFF-8482 Cable

These controllers can be installed in a server RAID enclosure with out a backplane. The kind of cable will attach directly to the SAS disk drives. The following diagram shows the picture of Mini SAS HD SFF-8643 to 4xSFF-8482 cables.

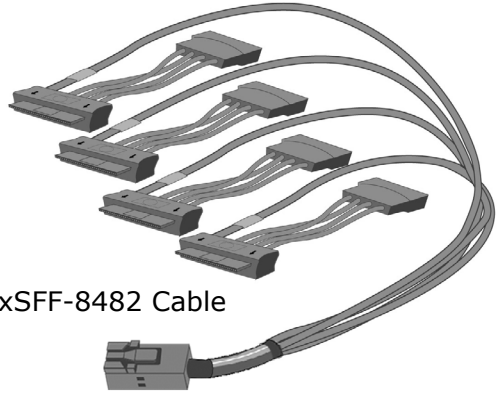

Figure 2-12, SFF-8643 to 4xSFF-8482 Cable

2.4.3 Mini SAS HD SFF-8643 Cable

The 12Gb/s SAS RAID controllers have 1-6 Mini SAS HD SFF-8643 connectors, each of them can support up to four SAS/SATA signals. These controllers can be installed in a server RAID enclosure with Mini SAS HD SFF-8643 internal connectors backplane. This Mini SAS HD cable has eight signal pins to support four SAS/SATA drives and six pins for the SGPIO (Serial General Purpose Input/Output) side-band signals. The SGPIO bus is used for efficient LED management and sensing drive Locate status.

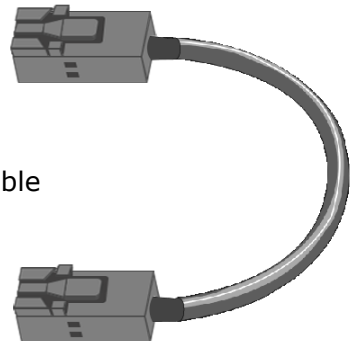

Figure 2-13, Mini SAS HD SFF-8643 Cable

HARDWARE INSTALLATION

2.4.4 Mini SAS HD SFF-8644 Cable

The Mini SAS HD SFF-8644 cables are used for connection between the 12Gb/s SAS controller external connectors and connectors on the external drive boxes or drive expanders (JBOD). The 12Gb/s SAS controller has Mini SAS HD SFF-8644 external connectors, each of them can support up to four SAS/SATA signals.

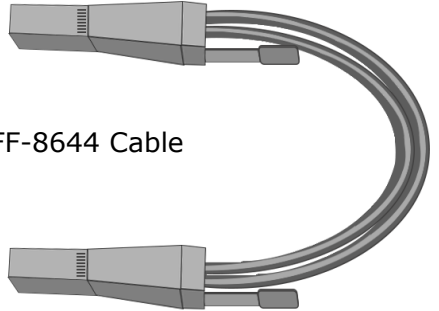
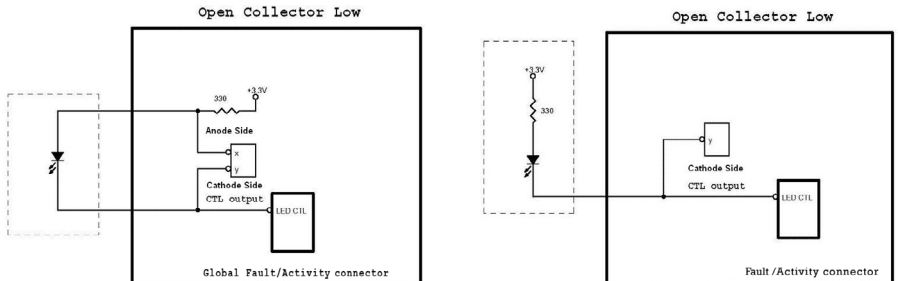

Figure 2-14, Mini SAS HD SFF-8644 Cable

2.5 LED Cables

There is no SGPIO supported in the most of old version SATA backplane. The 12Gb/s SAS controller also provides two kinds of alternative LED cable header to support the fault/activity status for those backplanes. The global indicator connector is used by the server global indicator LED.

The following electronics schematic is the 12Gb/s SAS RAID controller logical of fault/activity header. The signal for each pin is cathode (-) side. The following diagrams and descriptions describe each type of indicator connector.



HARDWARE INSTALLATION

1. Individual Activity/Fault LED and Global Indicator Connector

Most of the backplane has supported the HDD activity from the HDD. The 12Gb/s SAS RAID controller also provides the fault activity for fault LED. Connect the cables for the drive fault LEDs between the backplane of the cage and the respective connector on the 12Gb/s SAS RAID controller.

The following table is the fault LED signal behavior.

LED	Normal Status	Problem Indication
Fault LED	<ol style="list-style-type: none"> 1. When the fault LED is lit, there is no disk present. 2. When the fault LED is not lit, then disk is present and status is normal. 	<ol style="list-style-type: none"> 1. When the fault LED is blinking (2 times/sec), that disk drive has failed and should be hot swapped immediately. 2. When the activity LED is lit and fault LED is fast blinking (10 times/sec) there is rebuilding activity on that disk drive.

If the system will use only a single global indicator, attach the LED to the two pins of the global activity/fault connector. The global fault pin pair connector is the overall fault signal. This signal will light up in any disk drive failure.

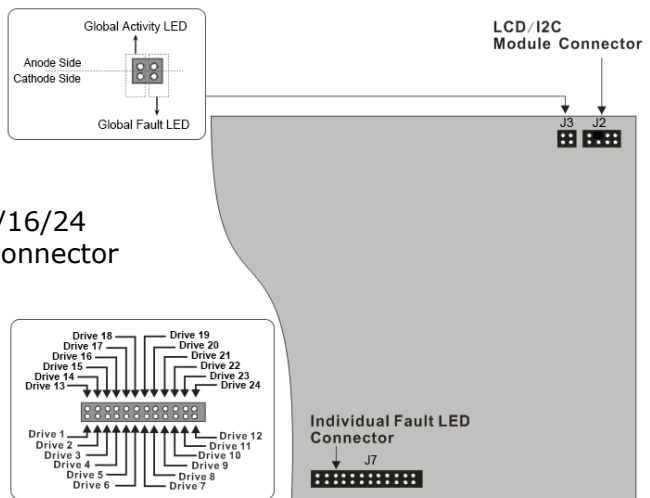

Figure 2-15,
ARC-1883ix-12/16/24
LED Indicator Connector

HARDWARE INSTALLATION

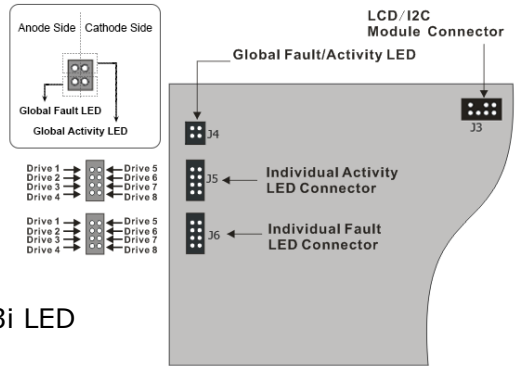

Figure 2-16, ARC-1883i LED Indicator Connector

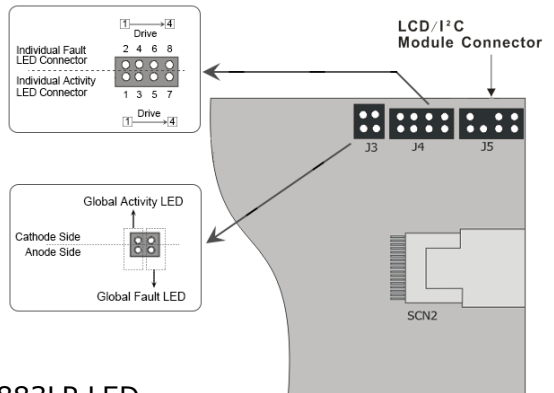

Figure 2-17, ARC-1883LP LED Indicator Connector

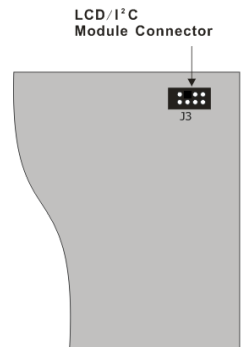

Figure 2-18, ARC-1883x LED Indicator Connector

HARDWARE INSTALLATION

Note:

A cable for the global indicator comes with your computer system. Cables for the individual drive LEDs may come with a drive cage, or you may need to purchase them.

2. Areca Serial Bus Connector

The serial bus connector can add optional accessories to add RAID controller more functions. You can connect this interface to Areca LCD module for information, status indication, or menus or Card LED indicator for status message. This interface can also cascade to another Areca serial bus accessories for the additional status display.

The following picture and table are the serial bus signal name description for LCD & fault/activity LED.

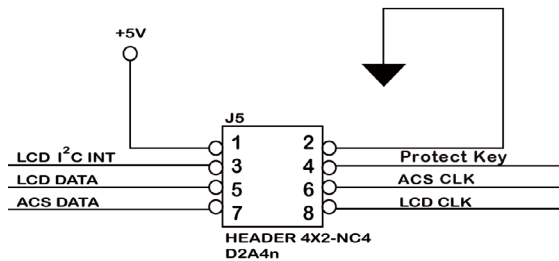

Pin	Description	Pin	Description
1	Power (+5V)	2	GND
3	LCD Module Interrupt	4	Protect Key
5	LCD Module Serial Data	6	Fault/Activity Clock
7	Fault/Activity Serial Data	8	LCD Module Clock

You can use one optional LCD front panel and keypad function to simply create the RAID volume. The LCD status panel also informs you of the disk array's current operating status at a glance. The LCD configuration is described in a separate manual: RAID Card_LCD manual. The LCD housed in a 5¼-inch half-height or 3.5-inch canister.

HARDWARE INSTALLATION

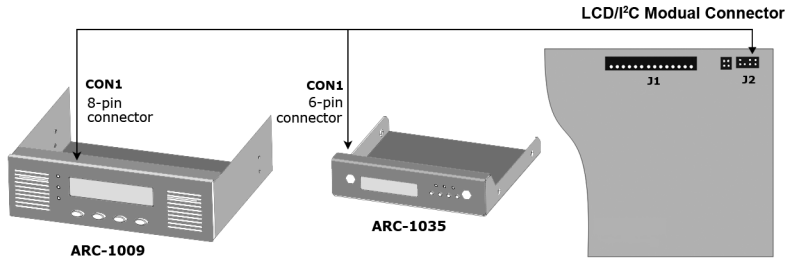

Figure 2-19, Connect to LCD Status Panel

2.6 Hot-plug Drive Replacement

The RAID controller supports the ability of performing a hot-swap drive replacement without powering down the system. A disk can be disconnected, removed, or replaced with a different disk without taking the system off-line. The RAID rebuilding will be processed automatically in the background. When a disk is hot swap, the RAID controller may no longer be fault tolerant. Fault tolerance will be lost until the hot swap drive is subsequently replaced and the rebuild operation is completed.

2.6.1 Recognizing a Drive Failure

A drive failure can be identified in one of the following ways:

1. An error status message lists failed drives in the event log.
2. A fault LED illuminates on the front of RAID subsystem if failed drives are inside.

2.6.2 Replacing a Failed Drive

With RAID subsystem drive tray, you can replace a defective physical drive while your computer is still operating. When a new drive has been installed, data reconstruction will be automatically started to rebuild the contents of the disk drive. The controller always uses the smallest hotspare that "fits". If a hotspare is used and the defective drive is exchanged on-line, the new inserted HDD will automatically assign as a hotspare HDD.

HARDWARE INSTALLATION

Note:

The capacity of the replacement drives must be at least as large as the capacity of the other drives in the raid set. Drives of insufficient capacity will be failed immediately by the RAID controller without starting the "Automatic Data Rebuild".

2.7 Summary of the installation

The flow chart below describes the installation procedures for 12Gb/s SAS RAID controllers. These procedures include hardware installation, the creation and configuration of a RAID volume through the McBIOS/McRAID manager, OS installation and installation of 12Gb/s SAS RAID controller software.

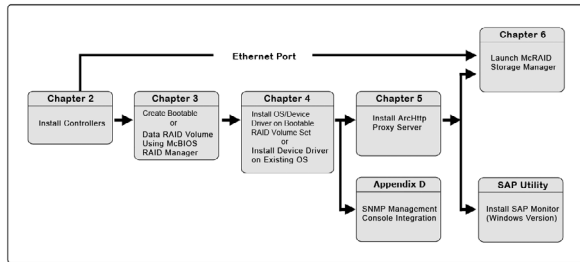

The table below shows the software components that configure and monitor the 12Gb/s SAS RAID controllers.

Configuration Utility	Operating System Supported
McBIOS RAID Manager	OS-Independent
McRAID Storage Manager (Via Ethernet port)	OS-Independent
McRAID Storage Manager (Via ArchHTTP proxy server)	Windows, Linux, FreeBSD, Solaris and Mac OS X
ArchHTTP Proxy Server	Windows, Linux, FreeBSD, Solaris and Mac OS X
CLI Utility	Windows, Linux, FreeBSD, Solaris and Mac OS X
SNMP Manager Console Integration	Windows, Linux, FreeBSD and Solaris
SAP Monitor (Single Admin Portal to scan for multiple RAID units in the network, via ArchHTTP proxy server)	Windows

HARDWARE INSTALLATION

McRAID Storage Manager

Before launching the firmware-embedded web browser, McRAID storage manager through the PCIe bus, you need first to install the ArchHTTP proxy server on your server system. If you need additional information about installation and start-up of this function, see the McRAID Storage Manager section in Chapter 6 of the user manual.

ArchHTTP Proxy Server

ArchHTTP has to be installed for GUI RAID console (MRAID storage manager) to run. It is used to launch the web browser McRAID storage manager. It also runs as a service or daemon in the background that allows capturing of events for mail and SNMP traps notification. If you need additional information about installation and start-up of this function, see the ArchHTTP Proxy Server Installation section in Chapter 5 of the user manual.

CLI Utility

CLI (Command Line Interface) lets you set up and manage RAID controller through a command line interface. CLI performs many tasks at the command line. You can download CLI manual from Areca website or software CD <CDROM>\DOCS directory.

SNMP Manager Console Integration

There are two ways to transport SNMP data on the 12Gb/s SAS RAID controller: in-band PCIe host bus interface or out-of-band built-in LAN interface. Enter the "SNMP Tarp IP Address" option on the firmware-embedded SNMP configuration function for user to select the SNMP data agent-side communication from the out-of-band built-in LAN interface. To use in-band PCIe host bus interface, keep blank on the "SNMP Tarp IP Address" option.

- **Out of Band-Using LAN Port Interface**

Out-of-band interface refers to transport SNMP data of 12Gb/s SAS controllers from a remote station connected to the controller through a network cable. Before launching the SNMP manager on the client, you need firstly to enable the firmware-embedded

HARDWARE INSTALLATION

SNMP agent function and no additional agent software inquired on your server system. If you need additional information about installation and start-up this function, see the section 6.8.4 “SNMP Configuration” of the user manual.

- **In-Band-Using PCIe Host Bus Interface**

In-band interface refers to management of the SNMP data of 12Gb/s SAS controllers from a PCIe host bus. In-band interface is simpler than out-of-band interface for it requires less hardware in its configuration. Since the 12 Gb/s SAS RAID controller is already installed in the host system, no extra connection is necessary. Just load the necessary in-band Areca SNMP extension agent for the controllers. Before launching the SNMP agent in the sever, you need first to enable the firmware-embedded SNMP community configuration and install Areca SNMP extension agent in your server system. If you need additional information about installation and start-up the function, see the SNMP Operation & Installation section in the Appendix D of the user manual.

Single Admin Portal (ArcSAP) Monitor

This utility can scan for multiple RAID units in the local and remote systems and provide an effective mechanism to configure and monitor your RAID units. For additional information, see the utility manual (ArcSAP) in the packaged CD or download it from the web site **<http://www.areca.com.tw>**.

BIOS CONFIGURATION

3. McBIOS RAID Manager

The system mainboard BIOS automatically configures the following SAS RAID controller parameters at power-up:

- I/O Port Address,
- Interrupt Channel (IRQ) and
- Controller ROM Base Address.

Use McBIOS RAID manager to further configure the SAS RAID controller to suit your server hardware and operating system.

3.1 Starting the McBIOS RAID Manager

This section explains how to use the McBIOS RAID manager to configure your RAID system. The McBIOS RAID manager is designed to be user-friendly. It is a menu-driven program, residing in the firmware, which allows you to scroll through various menus and sub-menus and select among the predetermined configuration options.

When starting a system with a SAS RAID controller installed, it will display the following message on the monitor during the start-up sequence (after the system BIOS startup screen but before the operating system boots):

```
ARC-1883 PCIEx8/8G RAID Controller - DRAM: 2048(MB) / #Channels: 8
BIOS: V1.24 / Date: 2016-04-15 - F/W: V1.54 / Date: 2018-01-10
```

```
▶ Bus/Dev/Fun= 4/0/0, I/O-Port=28000000h, IRQ=11, BIOS=C800 : 0h
▶▶ ID-LUN=00-0, Vol="Areca ARC-1883-VOL#000R001", Size=3.6 (TB)
▶▶ ID-LUN=00-1, Vol="Areca ARC-1883-VOL#001R001", Size=3.6 (TB)
▶▶ ID-LUN=00-2, Vol="Areca ARC-1883-VOL#002R001", Size=3.6 (TB)
▶▶ RAID controller BIOS not installed
▶▶ Press <Tab/F6> to enter SETUP menu. 9 second(s) left <ESC to Skip>..
```

The McBIOS RAID manager message remains on your screen for about nine seconds, giving you time to start the configuration menu by pressing **Tab** or **F6**. If you do not wish to enter configuration menu, press **ESC** to skip configuration immediately. When activated, the McBIOS RAID manager window appears showing a selection dialog box listing the SAS RAID controllers that are installed in the system.

BIOS CONFIGURATION

The legend at the bottom of the screen shows you what keys are enabled for the windows.

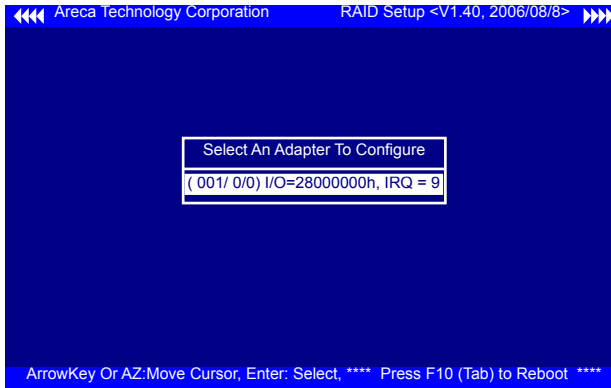

Use the **Up** and **Down** arrow keys to select the controller you want to configure. While the desired controller is highlighted, press the **Enter** key to enter the main menu of the McBIOS RAID manager.

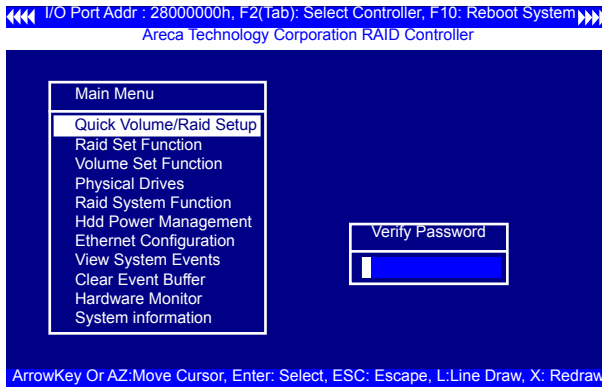

Note:
The manufacture default password is set to **0000**; this password can be modified by selecting **Change Password** in the **Raid System Function** section.

3.2 McBIOS RAID manager

The McBIOS RAID manager is firmware-based and is used to configure RAID sets and volume sets. Because the utility resides in the SAS RAID controller firmware, operation is independent of any operating systems on your computer. This utility can be used to:

- Create RAID sets,
- Expand RAID sets,

BIOS CONFIGURATION

- Add physical drives,
- Define volume sets,
- Modify volume sets,
- Modify RAID level/stripe size,
- Define pass-through disk drives,
- Modify system functions and
- Designate drives as hot spares.

3.3 Configuring Raid Sets and Volume Sets

You can configure RAID sets and volume sets with McBIOS RAID manager automatically. Using "Quick Volume/Raid Setup" or manually using "Raid Set/Volume Set Function". Each configuration method requires a different level of user input. The general flow of operations for RAID set and volume set configuration is:

Step	Action
1	Designate hot spares/pass-through drives (optional).
2	Choose a configuration method.
3	Create RAID sets using the available physical drives.
4	Define volume sets using the space available in the RAID set.
5	Initialize the volume sets and use volume sets (as logical drives) in the host OS.

3.4 Designating Drives as Hot Spares

Any unused disk drive that is not part of a RAID set can be designated as a hot spare. The "Quick Volume/Raid Setup" configuration will add the spare disk drive and automatically display the appropriate RAID level from which the user can select. For the "Raid Set Function" configuration option, the user can use the "Create Hot Spare" option to define the hot spare disk drive.

When a hot spare disk drive is being created using the "Create Hot Spare" option (in the "Raid Set Function"), all unused physical devices connected to the current controller appear:

Choose the target disk by selecting the appropriate check box. Press **Enter** key to select a disk drive, and press **Yes** in the "Create Hot Spare" to designate it as a hot spare.

BIOS CONFIGURATION

3.5 Using Quick Volume /Raid Setup Configuration

“Quick Volume / Raid Setup configuration” collects all available drives and includes them in a RAID set. The RAID set you created is associated with exactly one volume set. You will only be able to modify the default RAID level, stripe size and capacity of the new volume set. Designating drives as hot spares is also possible in the “Raid Level” selection option. The volume set default settings will be:

Parameter	Default Setting
Volume Name	ARC-1883-VOL#00
SCSI Channel/SCSI ID/SCSI LUN	0/0/0
Cache Mode	Write-Back
Tag Queuing	Yes

The default setting values can be changed after configuration is completed. Follow the steps below to create arrays using the “Raid Set / Volume Set” method:

Step	Action
1	Choose “Quick Volume /Raid Setup” from the main menu. The available RAID levels with hot spare for the current volume set drive are displayed.
2	<p>It is recommended that you use drives of the same capacity in a specific array. If you use drives with different capacities in an array, all drives in the RAID set will be set to the capacity of the smallest drive in the RAID set.</p> <p>The numbers of physical drives in a specific array determines which RAID levels that can be implemented in the array.</p> <p>RAID 0 requires 1 or more physical drives.</p> <p>RAID 1 requires at least 2 physical drives.</p> <p>RAID 10(1E) requires at least 3 physical drives.</p> <p>RAID 3 requires at least 3 physical drives.</p> <p>RAID 5 requires at least 3 physical drives.</p> <p>RAID 3 +Spare requires at least 4 physical drives.</p> <p>RAID 5 + Spare requires at least 4 physical drives.</p> <p>RAID 6 requires at least 4 physical drives.</p> <p>RAID 6 + Spare requires at least 5 physical drives.</p> <p>Highlight the desired RAID level for the volume set and press the Enter key to confirm.</p>

BIOS CONFIGURATION

3	The capacity for the current volume set is entered after highlighting the desired RAID level and pressing the Enter key. The capacity for the current volume set is displayed. Use the UP and DOWN arrow keys to set the capacity of the volume set and press the Enter key to confirm. The available stripe sizes for the current volume set are then displayed.
4	Use the UP and DOWN arrow keys to select the current volume set stripe size and press the Enter key to confirm. This parameter specifies the size of the stripes written to each disk in a RAID 0, 1, 10(1E), 5 or 6 volume set. You can set the stripe size to 4 KB, 8 KB, 16 KB, 32 KB, 64 KB, 128 KB, 256KB, 512KB, or 1024KB. A larger stripe size provides better read performance, especially when the computer performs mostly sequential reads. However, if the computer performs random read requests more often, choose a smaller stripe size.
5	When you are finished defining the volume set, press the Yes key to confirm the "Quick Volume And Raid Set Setup" function.
6	Foreground (Fast Completion) Press Enter key to define fast initialization or selected the Background (Instant Available) or No Init (To Rescue Volume). In the "Background Initialization", the initialization proceeds as a background task, the volume set is fully accessible for system reads and writes. The operating system can instantly access to the newly created arrays without requiring a reboot and waiting the initialization complete. In "Foreground Initialization", the initialization proceeds must be completed before the volume set ready for system accesses. In "No Init", there is no initialization on this volume.
7	Initialize the volume set you have just configured
8	If you need to add additional volume set, using main menu "Create Volume Set" function.

3.6 Using Raid Set/Volume Set Function Method

In "Raid Set Function", you can use the "Create Raid Set" function to generate a new RAID set. In "Volume Set Function", you can use the "Create Volume Set" function to generate an associated volume set and configuration parameters.

If the current controller has unused physical devices connected, you can choose the "Create Hot Spare" option in the "Raid Set Function" to define a global hot spare. Select this method to configure new RAID sets and volume sets. The "Raid Set/Volume Set Function" configuration option allows you to associate volume sets with partial and full RAID sets.

BIOS CONFIGURATION

Step	Action
1	To setup the hot spare (option), choose "Raid Set Function" from the main menu. Select the "Create Hot Spare" and press the Enter key to define the hot spare.
2	Choose "Raid Set Function" from the main menu. Select "Create Raid Set" and press the Enter key.
3	The "Select a Drive For Raid Set" window is displayed showing the SAS/SATA drives connected to the SAS RAID controller.
4	<p>Press the UP and DOWN arrow keys to select specific physical drives. Press the Enter key to associate the selected physical drive with the current RAID set.</p> <p>It is recommended that you use drives of the same capacity in a specific array. If you use drives with different capacities in an array, all drives in the RAID set will be set to the capacity of the smallest drive in the RAID set.</p> <p>The numbers of physical drives in a specific array determines which RAID levels that can be implemented in the array.</p> <p>RAID 0 requires 1 or more physical drives. RAID 1 requires at least 2 physical drives. RAID 10(1E) requires at least 3 physical drives. RAID 3 requires at least 3 physical drives. RAID 5 requires at least 3 physical drives. RAID 6 requires at least 4 physical drives. RAID 30 requires at least 6 physical drives. RAID 50 requires at least 6 physical drives. RAID 60 requires at least 8 physical drives.</p>
5	After adding the desired physical drives to the current RAID set, press the Enter to confirm the "Create Raid Set" function.
6	An "Edit The Raid Set Name" dialog box appears. Enter 1 to 15 alphanumeric characters to define a unique identifier for this new RAID set. The default RAID set name will always appear as Raid Set. #. Press Enter key to finish the name editing.
7	Press the Enter key when you are finished creating the current RAID set. To continue defining another RAID set, repeat step 3. To begin volume set configuration, go to step 8.
8	Choose the "Volume Set Function" from the main menu. Select "Create Volume Set" and press the Enter key.
9	Choose a RAID set from the "Create Volume From Raid Set" window. Press the Yes key to confirm the selection.

BIOS CONFIGURATION

10	Choosing Foreground (Fast Completion) Press Enter key to define fast initialization or selected the Background (Instant Available) or No Init (To Rescue Volume). In the "Background Initialization", the initialization proceeds as a background task, the volume set is fully accessible for system reads and writes. The operating system can instantly access to the newly created arrays without requiring a reboot and waiting the initialization complete. In "Foreground Initialization", the initialization proceeds must be completed before the volume set ready for system accesses. In "No Init", there is no initialization on this volume.
11	If space remains in the RAID set, the next volume set can be configured. Repeat steps 8 to 10 to configure another volume set.

3.7 Main Menu

The main menu shows all functions that are available for executing actions, which is accomplished by clicking on the appropriate link.

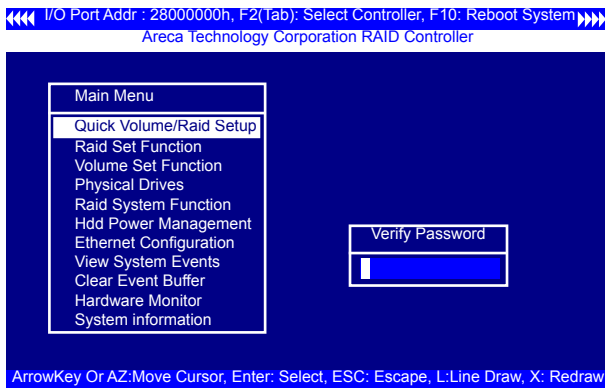

Note:

The manufacture default password is set to **0000**; this password can be modified by selecting "Change Password" in the "Raid System Function" section.

BIOS CONFIGURATION

Option	Description
Quick Volume/Raid Setup	Create a default configuration based on the number of physical disk installed
Raid Set Function	Create a customized RAID set
Volume Set Function	Create a customized volume set
Physical Drives	View individual disk information
Raid System Function	Setup the RAID system configuration
Hdd Power Management	Manage HDD power based on usage patterns
Ethernet Configuration	LAN port setting
View System Events	Record all system events in the buffer
Clear Event Buffer	Clear all information in the event buffer
Hardware Monitor	Show the hardware system environment status
System Information	View the controller system information

This password option allows user to set or clear the RAID controller's password protection feature. Once the password has been set, the user can only monitor and configure the RAID controller by providing the correct password. The password is used to protect the internal RAID controller from unauthorized entry. The controller will prompt for the password only when entering the main menu from the initial screen. The RAID controller will automatically return to the initial screen when it does not receive any command in five minutes.

3.7.1 Quick Volume/Raid Setup

"Quick Volume/Raid Setup" is the fastest way to prepare a RAID set and volume set. It requires only a few keystrokes to complete. Although disk drives of different capacity may be used in the RAID set, it will use the capacity of the smallest disk drive as the capacity of all disk drives in the RAID set. The "Quick Volume/Raid Setup" option creates a RAID set with the following properties:

1. All of the physical drives are contained in one RAID set.
2. The RAID level, hot spare, capacity, and stripe size options are selected during the configuration process.

BIOS CONFIGURATION

3. When a single volume set is created, it can consume all or a portion of the available disk capacity in this RAID set.
4. If you need to add an additional volume set, use the main menu "Create Volume Set" function.

The total number of physical drives in a specific RAID set determine the RAID levels that can be implemented within the RAID set. Select "Quick Volume/Raid Setup" from the main menu; all possible RAID level will be displayed on the screen.

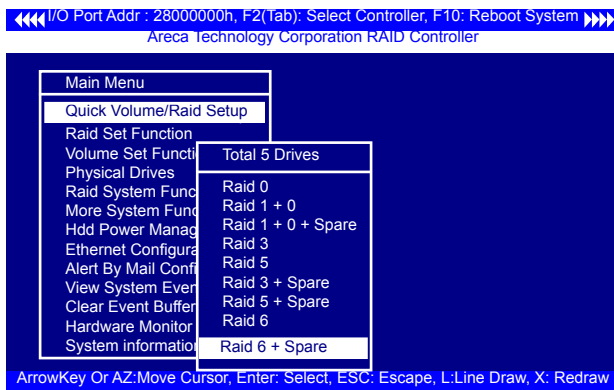

If volume capacity will exceed 2TB, controller will show the "Greater Two TB Volume Support" sub-menu.

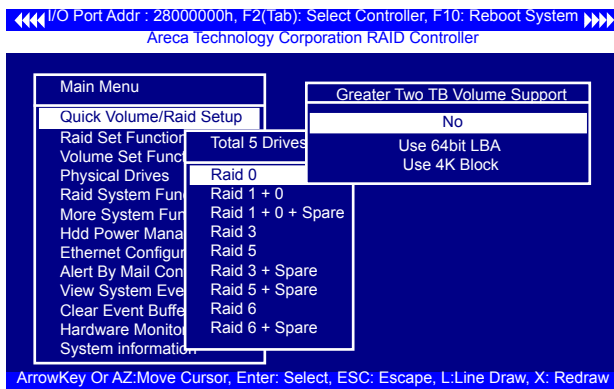

- **No**
When this option is enabled, it keeps the volume size with max. 2TB limitation.

BIOS CONFIGURATION

For any hard disk drives working in the 4K native mode in the Raid set, the volume set directly sets and exposes 4KB sector size to the operating system.

- **Use 64bit LBA**

This option use 16 bytes CDB instead of 10 bytes. The maximum volume capacity up to 512TB. For any hard disk drives working in the 4K native mode in the Raid set, the volume set directly sets and exposes 4KB sector size to the operating system. This option works on different OS which supports 16 bytes CDB. Such as:

Windows 2003 with SP1 or later
Linux kernel 2.6.x or later

- **Use 4K Block**

This option uses 16 bytes CDB and changes the sector size from default 512 bytes to 4k bytes. Windows XP only supports maximum volume capacity is up to 16TB.

A single volume set is created and consumes all or a portion of the disk capacity available in this RAID set. Define the capacity of volume set in the "Available Capacity" popup. The default value for the volume set, which is 100% of the available capacity, is displayed in the selected capacity. use the **UP** and **DOWN** arrow key to set capacity of the volume set and press **Enter** key to accept this value. If the volume set uses only part of the RAID set capacity, you can use the "Create Volume Set" option in the main menu to define additional volume sets.

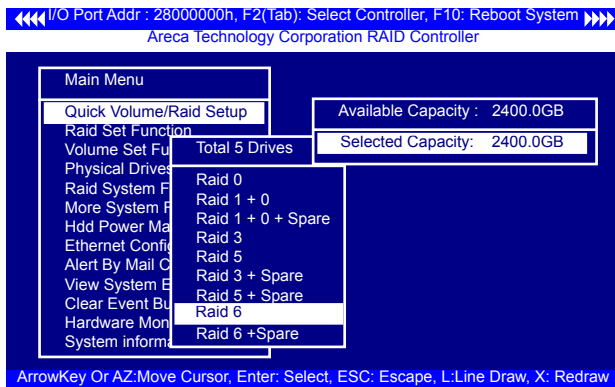

BIOS CONFIGURATION

Stripe Size This parameter sets the size of the stripe written to each disk in a RAID 0, 1, 1E, 10, 5, or 6 logical drive. You can set the stripe size to 4 KB, 8 KB, 16 KB, 32 KB, 64 KB, 128 KB, 256KB, 512KB, or 1024KB.

Warning:

Roaming the stripe size 256K/512K/1024K Raid Set to firmware version older than 1.52 will cause data corruption.

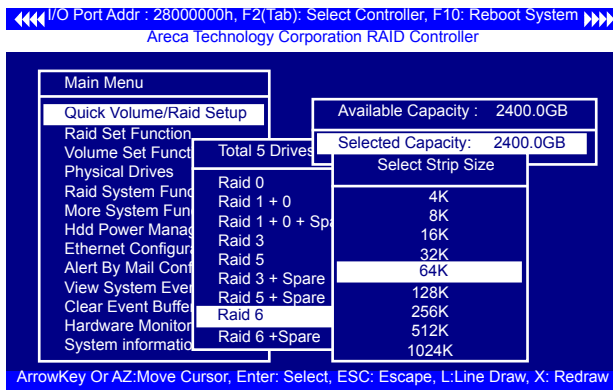

A larger stripe size produces better-read performance, especially if your computer does mostly sequential reads. However, if you are sure that your computer performs random reads more often, select a smaller stripe size.

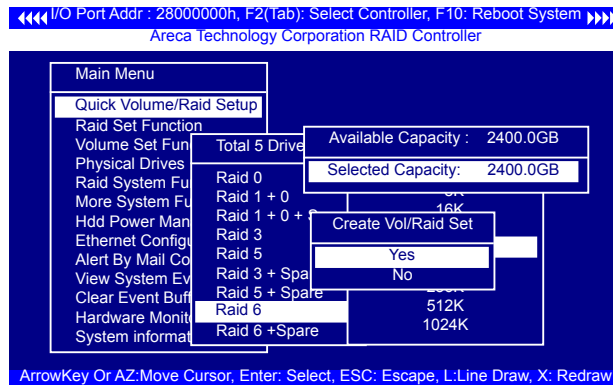

BIOS CONFIGURATION

Press **Yes** key in the "Create Vol/Raid Set" dialog box, the RAID set and volume set will start to initialize it. Select "Foreground (Faster Completion)" or "Background (Instant Available)" for initialization and "No Init (To Rescue Volume)" for recovering the missing RAID set configuration.

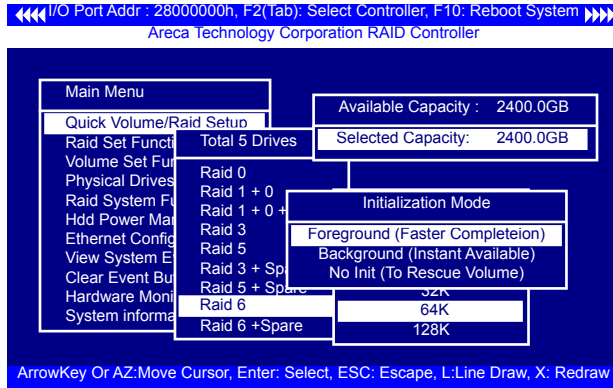

3.7.2 Raid Set Function

Manual configuration gives complete control of the RAID set setting, but it will take longer to configure than "Quick Volume/Raid Setup" configuration. Select "Raid Set Function" to manually configure the RAID set for the first time or delete existing RAID sets and reconfigure the RAID set.

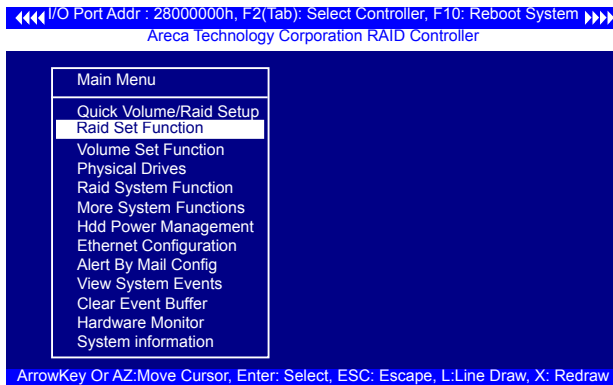

BIOS CONFIGURATION

3.7.2.1 Create Raid Set

The following is the RAID set features for the SAS RAID controller.

1. Up to 32 disk drives can be included in a single RAID set.
2. Up to 128 RAID sets can be created per controller, but RAID level 30 50 and 60 only can support eight sub-RAID set.

To define a RAID set, follow the procedures below:

1. Select "Raid Set Function" from the main menu.
2. Select "Create Raid Set " from the "Raid Set Function" dialog box.
3. A "Select IDE Drive For Raid Set" window is displayed showing the SAS/SATA drives connected to the current controller. Press the **UP** and **DOWN** arrow keys to select specific physical drives. Press the **Enter** key to associate the selected physical drive with the current RAID set. Repeat this step; the user can add as many disk drives as are available to a single RAID set.

When finished selecting SAS/SATA drives for RAID set, press **Esc** key. A "Create Raid Set Confirmation" screen will appear, select the **Yes** option to confirm it.

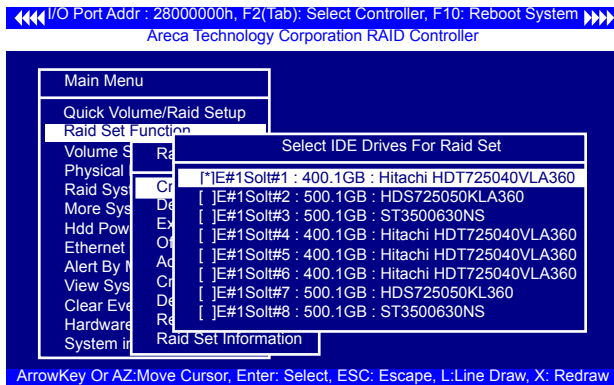

4. An "Edit The Raid Set Name" dialog box appears. Enter 1 to 15 alphanumeric characters to define a unique identifier for the RAID set. The default RAID set name will always appear as Raid Set. #.
5. Repeat steps 3 to define another RAID sets.

BIOS CONFIGURATION

Note:

To create RAID 30/50/60 volume, you need create multiple RAID sets (up to 8 RAID sets) first with the same disk numbers on each RAID set. The max no. disk drives per volume set:
32 for RAID 0/1/10/3/5/6 and 128 for RAID 30/50/60.

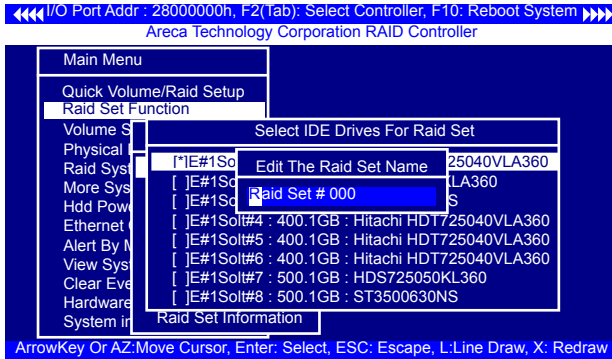

3.7.2.2 Delete Raid Set

To completely erase and reconfigure a RAID set, you must first delete it and re-create the RAID set. To delete a RAID set, select the RAID set number that you want to delete in the "Select Raid Set To Delete" screen. Then "Delete Raid Set" dialog box will appear, press the **Yes** to delete it. Warning, data on RAID set will be lost if this option is used. But for deleting RAID set with the Raid 30/50/60 volume, firstly, you need to delete the volumes belonging those RAID sets.

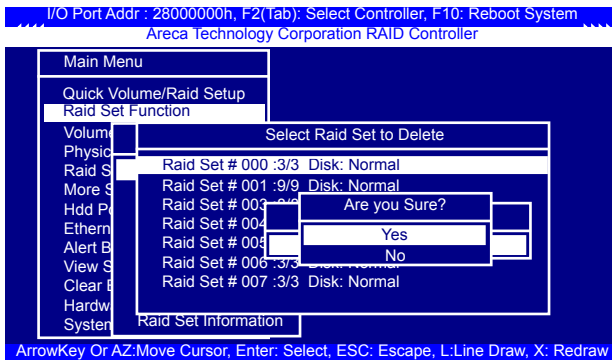

BIOS CONFIGURATION

3.7.2.3 Expand Raid Set

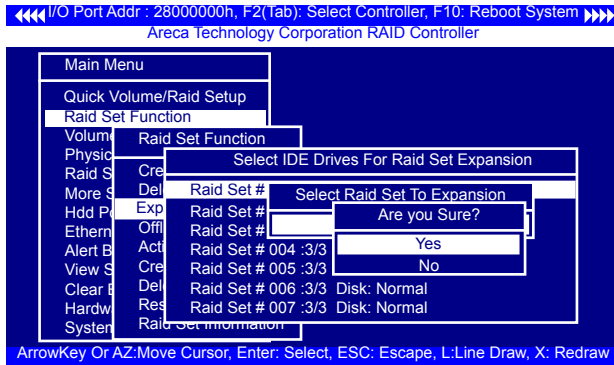

Instead of deleting a RAID set and recreating it with additional disk drives, the "Expand Raid Set" function allows the users to add disk drives to the RAID set that have already been created.

To expand a RAID set:

1. Select the "Expand Raid Set" option. If there is an available disk, then the "Select SAS/SATA Drives For Raid Set Expansion" screen appears.
2. Select the target RAID set by clicking on the appropriate radius button. Select the target disk by clicking on the appropriate check box.
3. Press the **Yes** key to start the expansion on the RAID set.

The new additional capacity can be utilized by one or more volume sets. The volume sets associated with this RAID set appear for you to have chance to modify RAID level or stripe size. Follow the instruction presented in the "Modify Volume Set" to modify the volume sets; operation system specific utilities may be required to expand operating system partitions.

Note:

1. Once the "Expand Raid Set" process has started, user can not stop it. The process must be completed.

BIOS CONFIGURATION

Note:

2. If a disk drive fails during RAID set expansion and a hot spare is available, an auto rebuild operation will occur after the RAID set expansion completes.
3. RAID 30/50/60 doesn't support the "Expand Raid Set".
4. RAID set expansion is a quite critical process, we strongly recommend customer backup data before expand. Unexpected accident may cause serious data corruption.

• Migrating

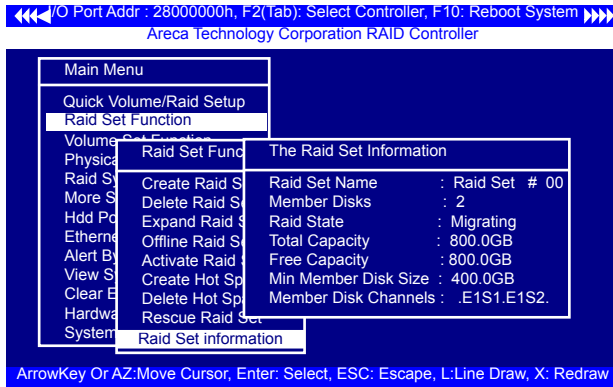

Migration occurs when a disk is added to a RAID set. Migrating state is displayed in the RAID state area of "The Raid Set Information" screen when a disk is being added to a RAID set. Migrating state is also displayed in the associated volume state area of the "Volume Set Information" which belongs to this RAID set.

3.7.2.4 Offline Raid Set

This function is for customer being able to unmount and remount a multi-disk volume. All Hdds of the selected RAID set will be put into offline state and spun down and fault LED will be in fast blinking mode. User can remove those Hdds and insert those Hdds on the other controller empty slots without needing power down the controller to perform the online array roaming.

BIOS CONFIGURATION

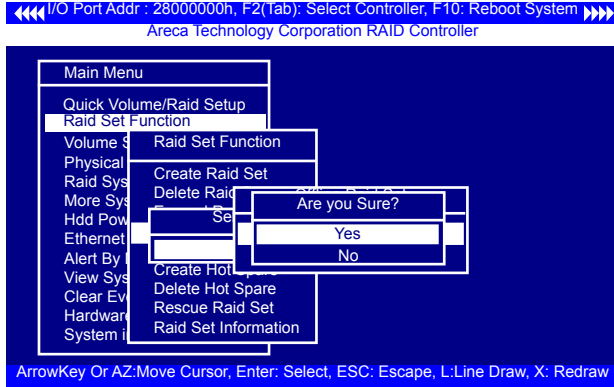

3.7.2.5 Activate Raid Set

The following screen is used to activate the RAID set after one of its disk drive was removed in the power off state.

When one of the disk drives is removed in power off state, the RAID set state will change to "Incomplete State". If user wants to continue to work while the SAS RAID controller is powered on, the user can use the "Activate Incomplete Raid Set" option to active the RAID set. After user selects this function, the RAID state will change to "Degraded Mode" and start to work.

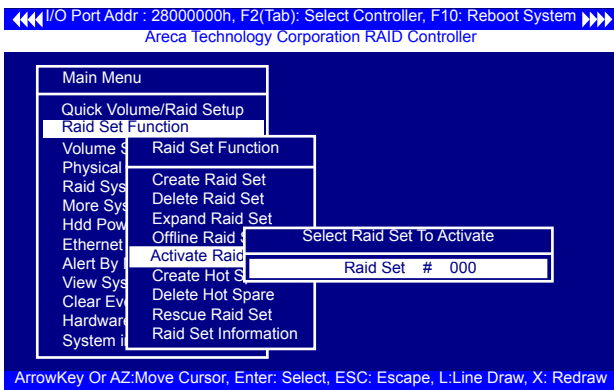

BIOS CONFIGURATION

3.7.2.6 Create Hot Spare

When you choose the "Create Hot Spare" option in the "Raid Set Function", all unused physical devices connected to the current controller will result in the screen.

Select the target disk by clicking on the appropriate check box. Press the **Enter** key to select a disk drive and press **Yes** in the "Create Hot Spare" to designate it as a hot spare.

The "Create Hot Spare" gives you the ability to define a global or dedicated hot spare. Unlike "Global Hot Spare" which can be used with any RAID sets, "Dedicated Hot Spare" can only be used with a specific RAID set or Enclosure. When a disk drive fails in the RAID set or enclosure with a dedicated hot spare is pre-set, data on the disk drive is rebuild automatically on the dedicated hot spare disk.

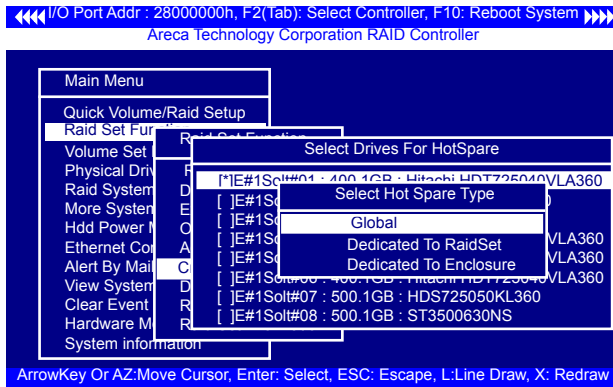

3.7.2.7 Delete Hot Spare

Select the target hot spare disk to delete by clicking on the appropriate check box.

Press the **Enter** key to select a hot spare disk drive, and press **Yes** in the "Delete Hot Spare" screen to delete the hot spare.

BIOS CONFIGURATION

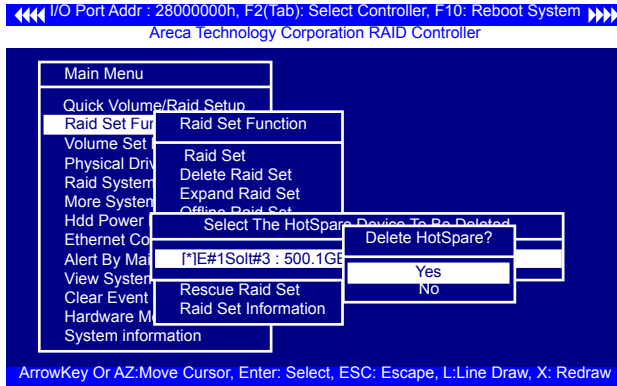

3.7.2.8 Rescue Raid Set

When the system is powered off in the RAID set update/creation period, it possibly could disappear due to this abnormal condition. The "RESCUE" function can recover the missing RAID set information. The RAID controller uses the time as the RAID set signature. The RAID set may have different time after the RAID set is recovered. The "SIGANT" function can regenerate the signature for the RAID set.

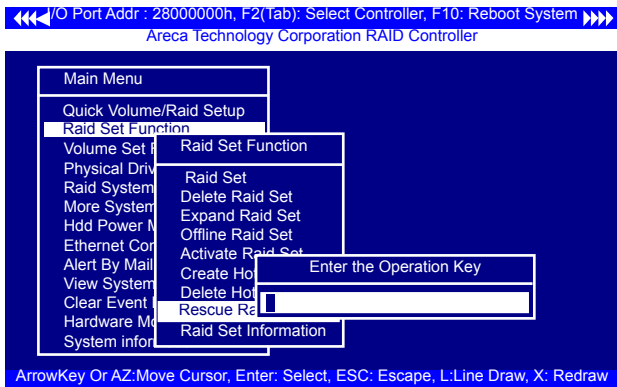

Note:

Please contact us to make sure if you need to use rescue function. Improperly usage may cause configuration corruption.

BIOS CONFIGURATION

3.7.2.9 Raid Set Information

To display RAID set information, move the cursor bar to the desired RAID set number, then press the **Enter** key. The "Raid Set Information" will appear. You can only view information for the RAID set in this screen.

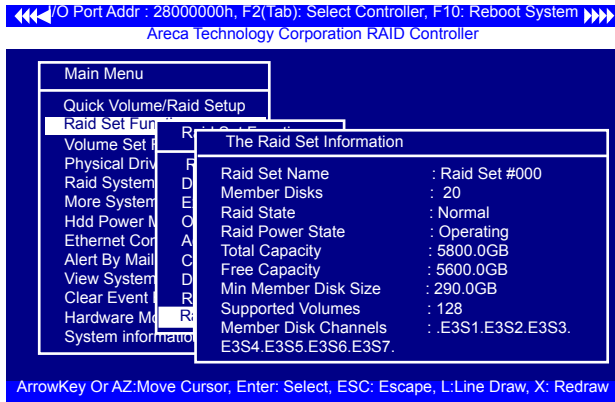

3.7.3 Volume Set Function

A volume set is seen by the host system as a single logical device; it is organized in a RAID level within the controller utilizing one or more physical disks. RAID level refers to the level of data performance and protection of a volume set. A volume set can consume all of the capacity or a portion of the available disk capacity of a RAID set. Multiple volume sets can exist on a RAID set. If multiple volume sets reside on a specified RAID set, all volume sets will reside on all physical disks in the RAID set. Thus each volume set on the RAID set will have its data spread evenly across all the disks in the RAID set rather than one volume set using some of the available disks and another volume set using other disks.

BIOS CONFIGURATION

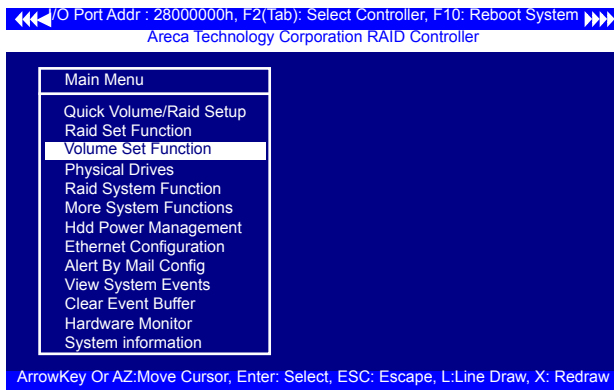

The following is the volume set features for the SAS RAID controller.

1. Volume sets of different RAID levels may coexist on the same RAID set and up to 128 volume sets per controller.
2. Up to 128 main volume sets can be created in a RAID set.
3. The maximum addressable size of a single volume set is not limited to 2TB, because the controller is capable of 64-bit LBA mode. However the operating system itself may not be capable of addressing more than 2TB.

See Areca website ftp://ftp.areca.com.tw/RaidCards/Documents/Manual_Spec/Over2TB_050721.ZIP file for details.

3.7.3.1 Create Volume Set (0/1/10/3/5/6)

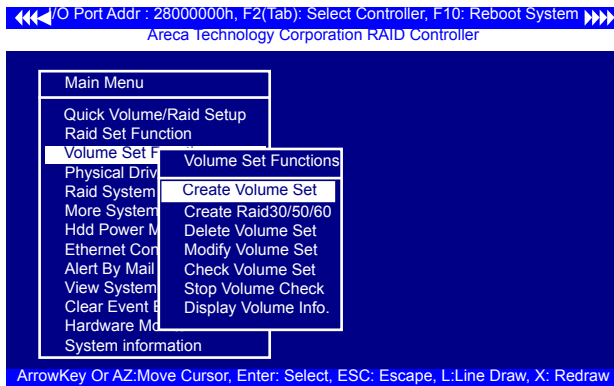

BIOS CONFIGURATION

To create a volume set, follow the below steps:

1. Select the "Volume Set Function" from the main menu.
2. Choose the "Create Volume Set" from "Volume Set Functions" dialog box screen.
3. The "Create Volume From Raid Set" appears. This screen displays the existing arranged RAID sets. Select the RAID set number and press the **Enter** key. The "Volume Creation" dialog is displayed in the screen.
4. The new create volume set attribute allows user to select the Volume Name, Raid level, Capacity, Strip Size, SCSI Channel/SCSI ID/SCSI Lun, Cache Mode, Write protect and Tagged Command Queuing.

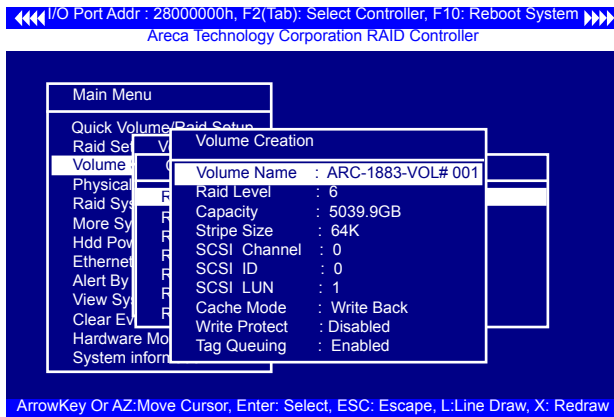

5. After completed the modification of the volume set, press the **Esc** key to confirm it. An "Initialization Mode" screen appears.

● Initialization Mode

- Select "Foreground (Faster Completion)" for faster initialization of the selected volume set.
- Select "Background (Instant Available)" for normal initialization of the selected volume set.
- Select "No Init (To Rescue Volume)" for no initialization of the selected volume.

BIOS CONFIGURATION

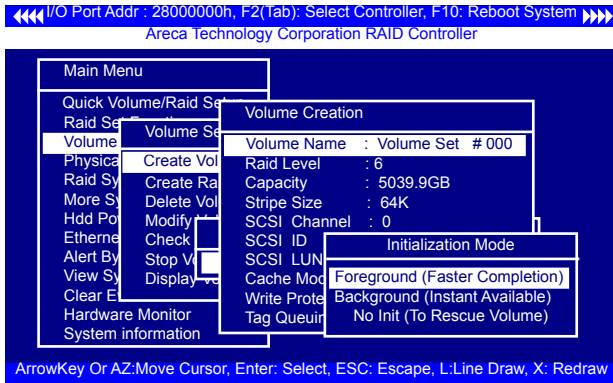

6. Repeat steps 3 to 5 to create additional volume sets.

7. The initialization percentage of volume set will be displayed at the button line.

Note:

Controller starts to initialize the volume in two conditions

1. Stay in controller bios manager or
2. Boot into OS and the controller driver loaded.

● Volume Name

The default volume name will always appear as ARC-1883-VOL #. You can rename the volume set providing it does not exceed the 15 characters limit.

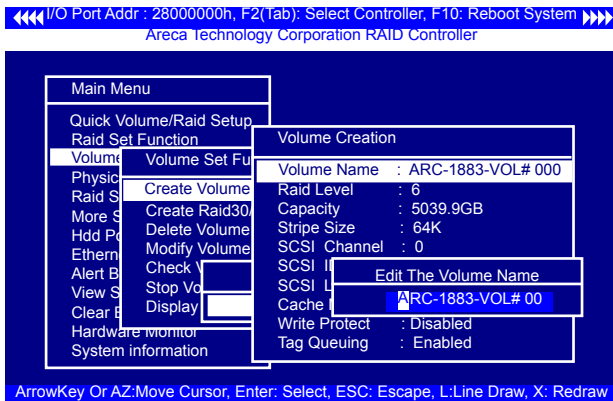

BIOS CONFIGURATION

● Raid Level

Set the "Raid Level" for the volume set. Highlight "Raid Level" and press the **Enter** key. The available RAID levels for the current volume set are displayed. Select a RAID level and press the **Enter** key to confirm.

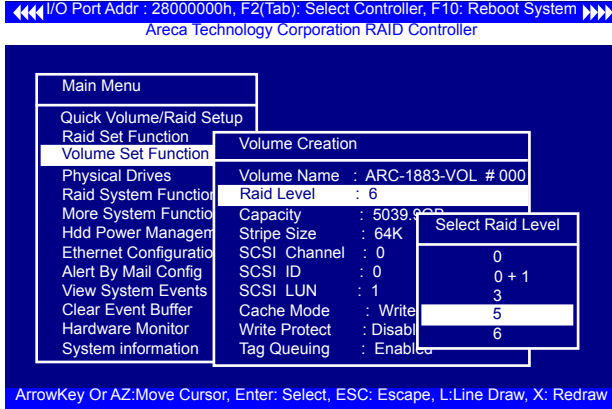

● Capacity

The maximum available volume size is the default value for the first setting. Enter the appropriate volume size to fit your application. The capacity value can be increased or decreased by the **UP** and **DOWN** arrow keys. The capacity of each volume set must be less than or equal to the total capacity of the RAID set on which it resides.

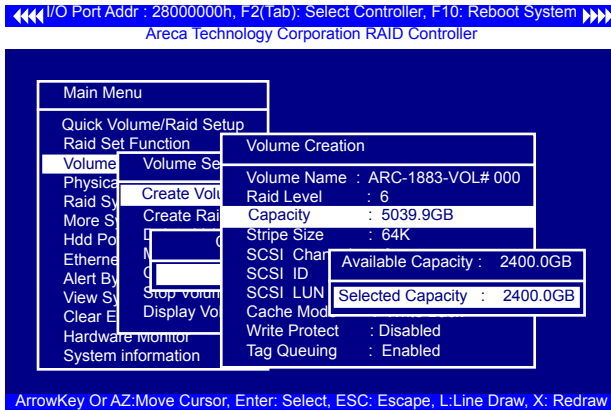

BIOS CONFIGURATION

If volume capacity will exceed 2TB, controller will show the "Greater Two TB Volume Support" sub-menu.

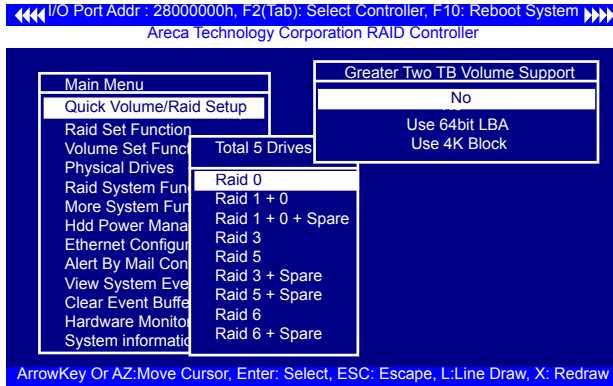

- **No**

When this option is enabled, it keeps the volume size with max. 2TB limitation.

For any hard disk drives working in the 4K native mode in the Raid set, the volume set directly sets and exposes 4KB sector size to the operating system.

- **Use 64bit LBA**

This option use 16 bytes CDB instead of 10 bytes. The maximum volume capacity up to 512TB. For any hard disk drives working in the 4K native mode in the Raid set, the volume set directly sets and exposes 4KB sector size to the operating system. This option works on different OS which supports 16 bytes CDB. Such as:

Windows 2003 with SP1 or later

Linux kernel 2.6.x or later

- **Use 4K Block**

This option uses 16 bytes CDB and changes the sector size from default 512 bytes to 4k bytes. Windows XP only supports maximum volume capacity is up to 16TB.

BIOS CONFIGURATION

● Stripe Size

This parameter sets the size of segment written to each disk in a RAID 0, 1, 1E, 10, 5, 6, 50 or 60 logical drive. You can set the stripe size to 4 KB, 8 KB, 16 KB, 32 KB, 64 KB, 128 KB, 256KB, 512KB, or 1024KB.

Warning:

Roaming the stripe size 256K/512K/1024K Raid Set to firmware version older than 1.52 will cause data corruption.

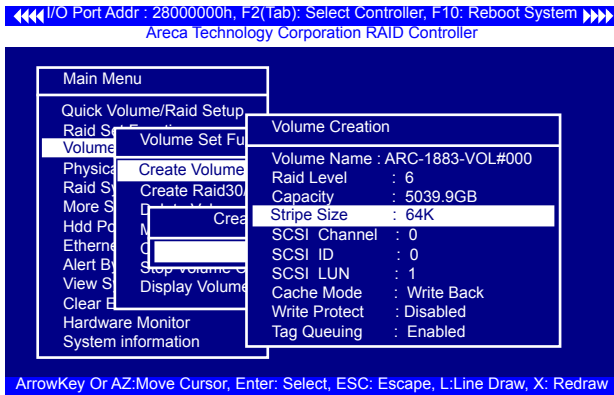

The SAS RAID controller function simulates a external SCSI RAID controller. The host bus represents the SCSI channel. Choose the "SCSI Channel". A "Select SCSI Channel" dialog box appears; select the channel number and press the **Enter** key to confirm it.

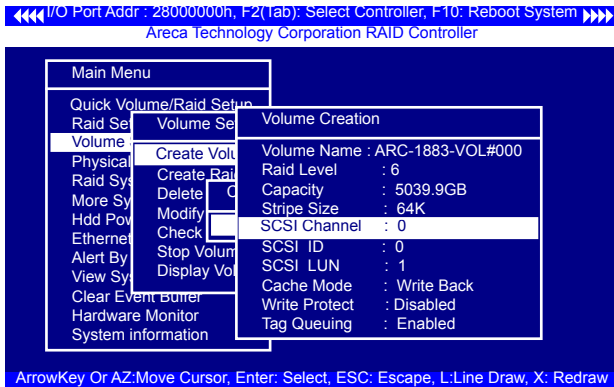

BIOS CONFIGURATION

● SCSI ID

Each device attached to the SAS RAID controller, as well as the SAS RAID controller itself, must be assigned a unique SCSI ID number. A SCSI channel can connect up to 15 devices. It is necessary to assign a SCSI ID to each device from a list of available SCSI IDs.

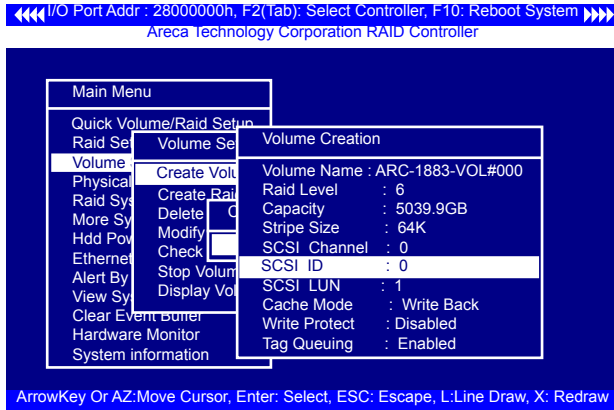

● SCSI LUN

Each SCSI ID can support up to 8 LUNs. Most SAS controllers treat each LUN as if it were a SAS disk.

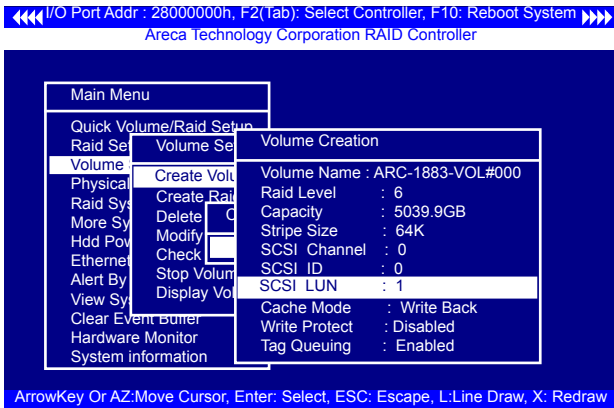

BIOS CONFIGURATION

- **Cache Mode**

User can set the cache mode to either "Write Through" or "Write Back".

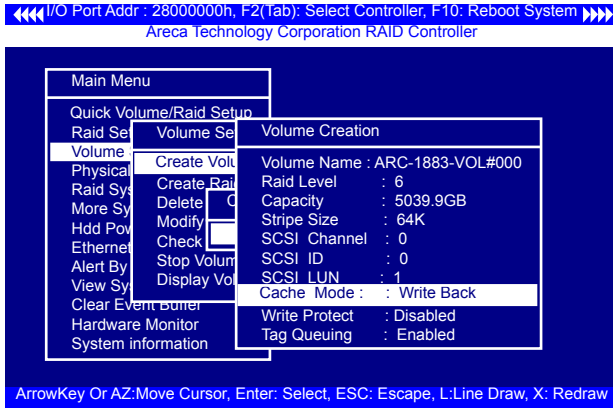

- **Write Protect**

When "Write Protect" is enabled on the "Create Volume Set", host commands fail if they are issued to a volume in that RAID controller and attempt to modify a volume's data or attributes. "Write Protection" is used primarily for customer-initiated disaster recovery testing.

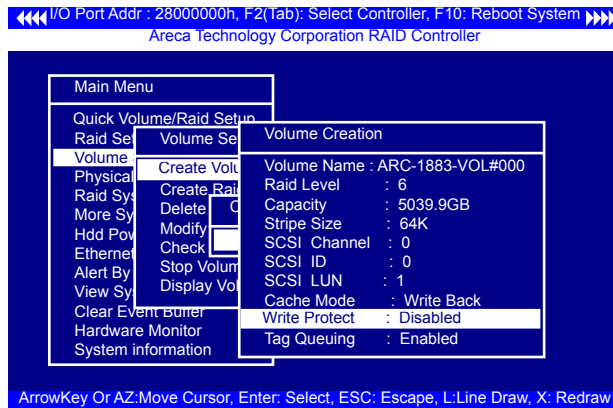

BIOS CONFIGURATION

● Tag Queuing

This option, when enabled, can enhance overall system performance under multi-tasking operating systems. The Command Tag (Drive Channel) function controls the SAS command tag queuing support for each drive channel. This function should normally remain enabled. Disabled this function only when using older drives that do not support command tag queuing. Tagged Command Queuing (TCQ) is a technology built into SAS hard drives. It allows the RAID controller to send multiple read and write requests to a hard drive. This function should normally remain "Enabled". "Disabled" this function only when using SAS drives that do not support command tag queuing.

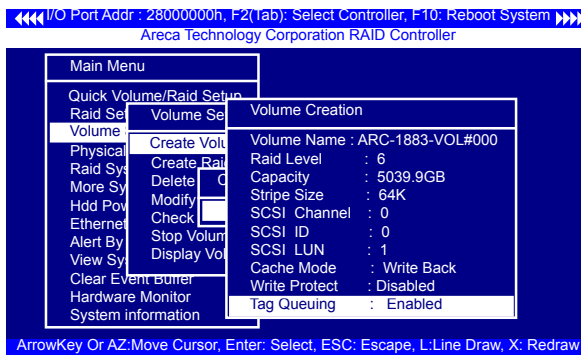

3.7.3.2 Create Raid30/50/60 (Volume Set 30/50/60)

To create 30/50/60 volume set from RAID set group, move the cursor bar to the main menu and click on the "Create Raid 30/50/60" link. The "Select The Raid Set To Create Volume On It" screen will show all RAID set number. Tick on the RAID set numbers (same number of disk per RAID set) that you want to create and then click on it.

The created new volume set attribute option allows users to select the Volume Name, Capacity, Raid Level, Strip Size, SCSI ID/LUN, Cache Mode, Write protect and Tagged Command Queuing. The detailed description of those parameters can refer to section 3.7.3.1. User can modify the default values in this screen; the modification procedures are in section 3.7.3.4.

BIOS CONFIGURATION

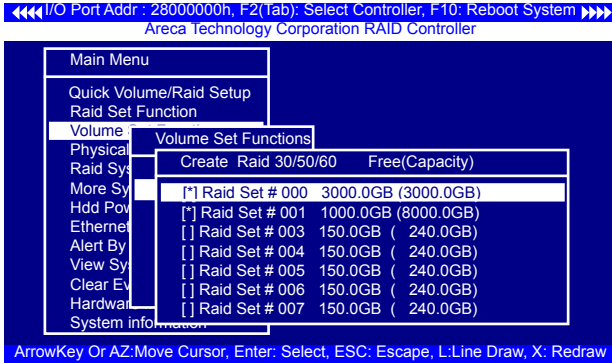

Note:

Raid Level 30 50 and 60 can support up to eight RAID sets (four pairs).

3.7.3.3 Delete Volume Set

To delete volume set from a RAID set, move the cursor bar to the "Volume Set Functions" menu and select the "Delete Volume Set" item, then press the **Enter** key. The "Volume Set Functions" menu will show all Raid Set # items. Move the cursor bar to a RAID set number, then press the **Enter** key to show all volume sets within that RAID set. Move the cursor to the volume set number that is to be deleted and press the **Enter** key to delete it.

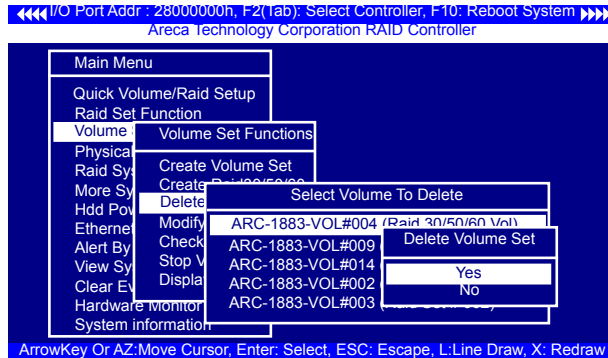

BIOS CONFIGURATION

3.7.3.4 Modify Volume Set

Use this option to modify volume set configuration. To modify volume set values from RAID set system function, move the cursor bar to the "Modify Volume Set" item, then press the **Enter** key. The "Volume Set Functions" menu will show all RAID set items. Move the cursor bar to a RAID set number item, then press the **Enter** key to show all volume set items. Select the volume set from the list to be changed, press the **Enter** key to modify it.

As shown, volume information can be modified at this screen. Choose this option to display the properties of the selected volume set. But user can only modify the last volume set capacity.

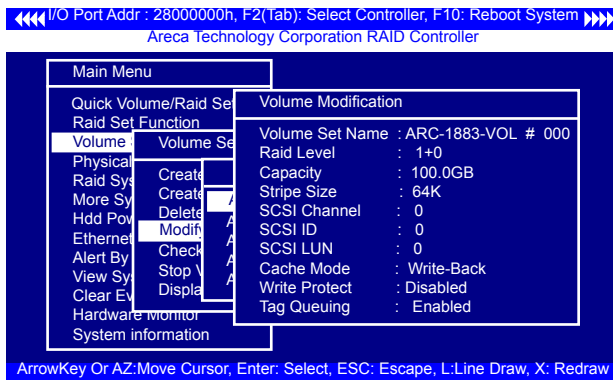

3.7.3.4.1 Volume Growth

Use "Expand Raid Set" function to add disk to a RAID set. The additional capacity can be used to enlarge the last volume set size or to create another volume set. The "Modify Volume Set" function can support the "Volume Modification" function. To expand the last volume set capacity, move the cursor bar to the "Capacity" item and entry the capacity size. When finished the above action, press the **ESC** key and select the **Yes** option to complete the action. The last volume set starts to expand its capacity.

BIOS CONFIGURATION

To expand an existing volume noticed:

- Only the last volume can expand capacity.
- When expand volume capacity, you can't modify stripe size or modify RAID level simultaneously.
- You can expand volume capacity, but can't reduce volume capacity size.
- After volume expansion, the volume capacity can not be decreased.

For greater 2TB expansion:

- If your system installed in the volume, don't expand the volume capacity greater 2TB, currently OS can't support boot up from a greater 2TB capacity device.
- Expand over 2TB used 64bit LBA mode. Please make sure your OS supports 64bit LBA before expand it.

3.7.3.4.2 Volume Set Migration

Migrating occurs when a volume set is migrating from one RAID level to another, when a volume set strip size changes, or when a disk is added to a RAID set. Migration state is displayed in the volume state area of the "Volume Set Information" screen.

Note:

Power failure may damage the migration data. Please backup the RAID data before you start the migration function.

BIOS CONFIGURATION

3.7.3.5 Check Volume Set

Use this option to verify the correctness of the redundant data in a volume set. For example, in a system with a dedicated parity disk drive, a volume set check entails computing the parity of the data disk drives and comparing those results to the contents of the dedicated parity disk drive. To check volume set, move the cursor bar to the "Check Volume Set" item, then press the **Enter** key. The "Volume Set Functions" menu will show all RAID set number items. Move the cursor bar to an RAID set number item and then press the **Enter** key to show all volume set items. Select the volume set to be checked from the list and press **Enter** key to select it. After completed the selection, the confirmation screen appears, press **Yes** to start the check.

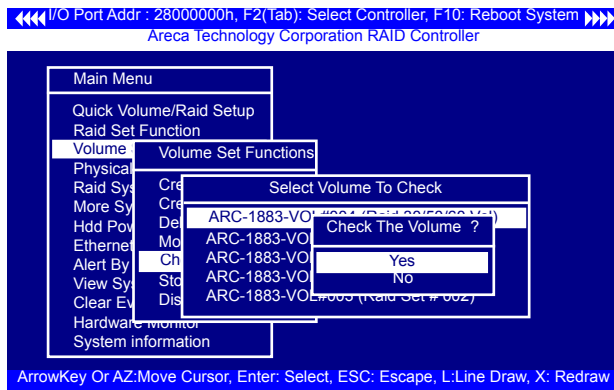

3.7.3.6 Stop Volume Check

Use this option to stop all of the "Check Volume Set" operations.

3.7.3.7 Display Volume Set Info.

To display volume set information, move the cursor bar to the desired volume set number and then press the **Enter** key. The "Volume Set Information" screen will be shown. You can only view the information of this volume set in this screen, but can not modify it.

BIOS CONFIGURATION

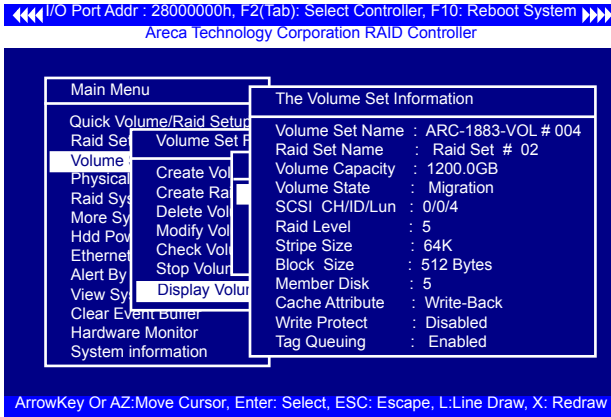

3.7.4 Physical Drives

Choose this option from the main menu to select a physical disk and perform the operations listed above. Move the cursor bar to an item, then press **Enter** key to select the desired function.

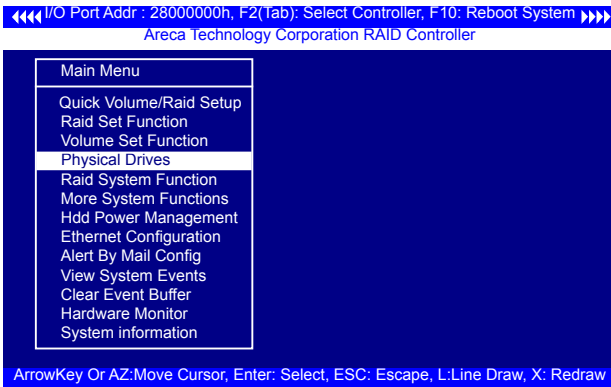

BIOS CONFIGURATION

3.7.4.1 View Drive Information

When you choose this option, the physical disks connected to the SAS RAID controller are listed. Move the cursor to the desired drive and press **Enter** key to view drive information.

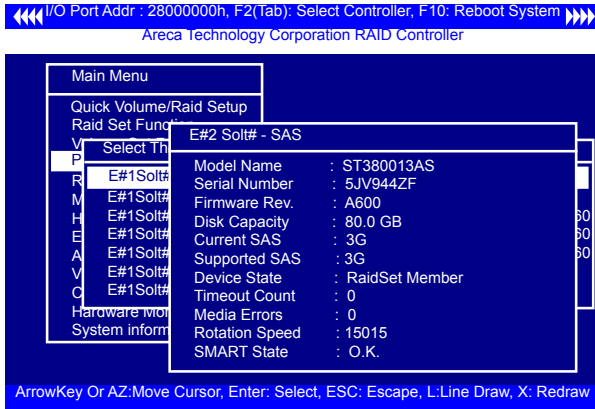

3.7.4.2 Create Pass-Through Disk

A pass-through disk is not controlled by the SAS RAID controller firmware and thus cannot be a part of a volume set. The disk is available directly to the operating system as an individual disk. It is typically used on a system where the operating system is on a disk not controlled by the SAS RAID controller firmware. The SCSI Channel/SCSI ID/SCSI LUN, Write Protect, Cache Mode, and Tag Queuing must be specified to create a pass-through disk.

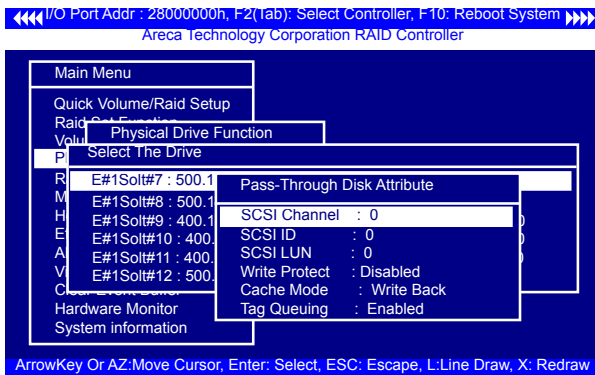

BIOS CONFIGURATION

3.7.4.3 Modify Pass-Through Disk

Use this option to modify "Pass-Through Disk Attributes". To select and modify a pass-through disk from the pool of pass-through disks, move the "Modify Pass-Through Drive" option and then press the **Enter** key. The "Physical Drive Function" menu will show all pass-through drive number options. Move the cursor bar to the desired number and then press the **Enter** key to show all pass-through disk attributes. Select the parameter from the list to be changed and then press the **Enter** key to modify it.

3.7.4.4 Delete Pass-Through Disk

To delete a pass-through drive from the pass-through drive pool, move the cursor bar to the "Delete Pass-Through Drive" item, then press the **Enter** key. The "Delete Pass-Through confirmation" screen will appear; select **Yes** to delete it.

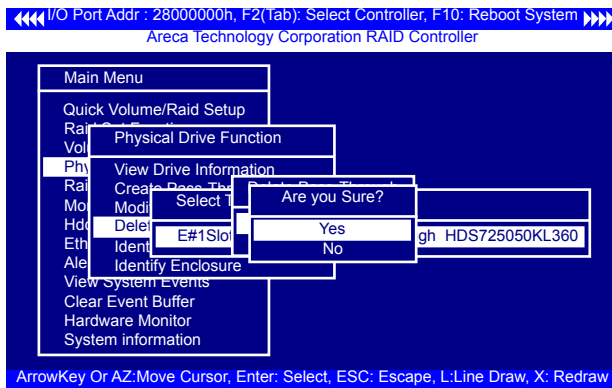

3.7.4.5 Set Disk To Be Failed

It sets a normal working disk as "failed" so that systems can test some of the features and functions.

BIOS CONFIGURATION

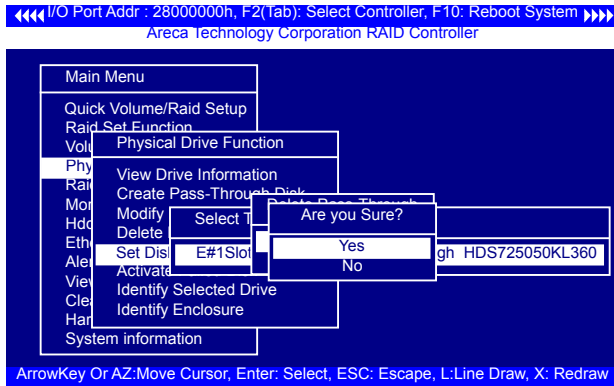

3.7.4.6 Activate Failed Disk

It forces the current “failed” disk in the system to be back on-line. “Activate Failed Disk” function has no effect on the removed disks, because a “removed” disk does not give the controller a chance to mark it as “failure”.

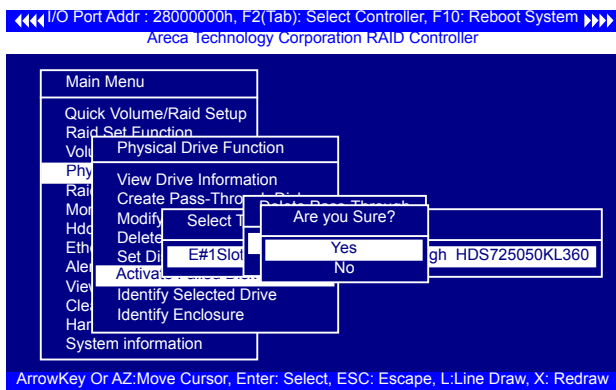

3.7.4.7 Identify Selected Drive

To prevent removing the wrong drive, the selected disk fault LED indicator will light for physically locating the selected disk when the “Identify Selected Device” is selected.

BIOS CONFIGURATION

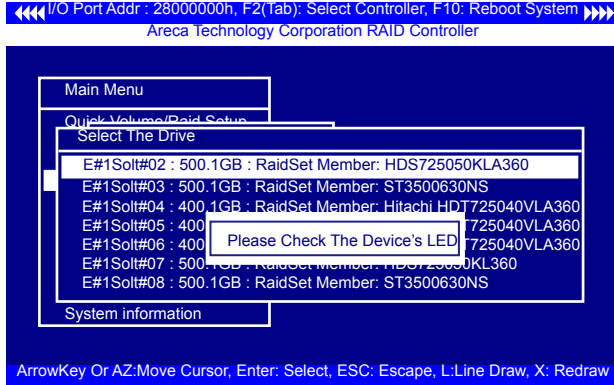

3.7.4.8 Identify Enclosure

To prevent removing the wrong enclosure, the selected Areca expander enclosure all disks fault LED indicator will light for physically locating the selected enclosure when the "Identify Enclosure" is selected. This function will also light the enclosure LED indicator, if it is existed.

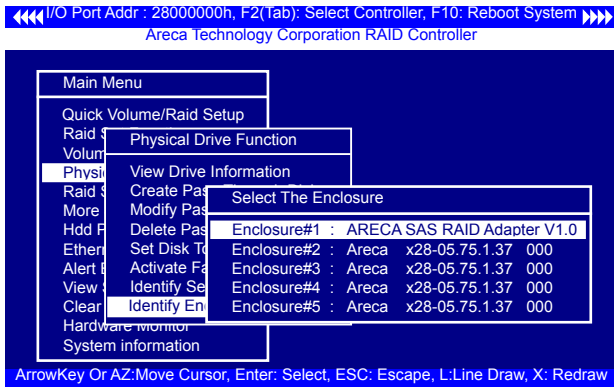

3.7.5 Raid System Function

To set the "Raid System Function", move the cursor bar to the main menu and select the "Raid System Function" item and then press **Enter** key. The "Raid System Function" menu will show multiple items. Move the cursor bar to an item, and then press **Enter** key to select the desired function.

BIOS CONFIGURATION

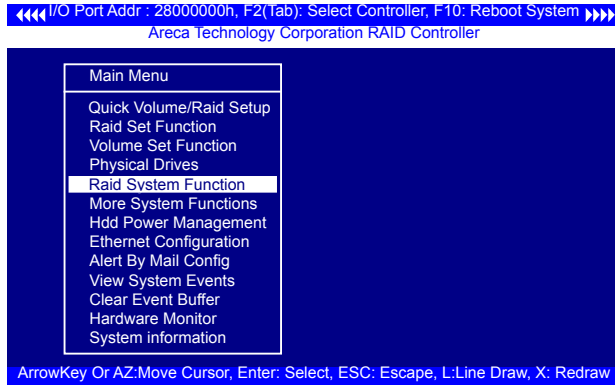

3.7.5.1 Mute The Alert Beeper

The “Mute The Alert Beeper” function item is used to control the SAS RAID controller beeper. Select **Yes** and press the **Enter** key in the dialog box to turn the beeper off temporarily. The beeper will still activate on the next event.

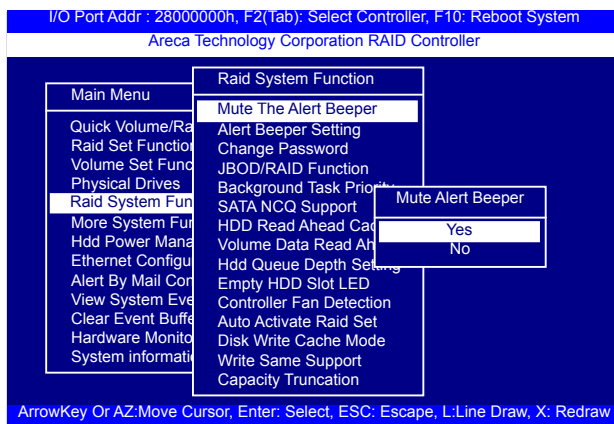

3.7.5.2 Alert Beeper Setting

The “Alert Beeper Setting” function item is used to “Disabled” or “Enabled” the SAS RAID controller alarm tone generator. Select “Disabled” and press the **Enter** key in the dialog box to turn the beeper off.

BIOS CONFIGURATION

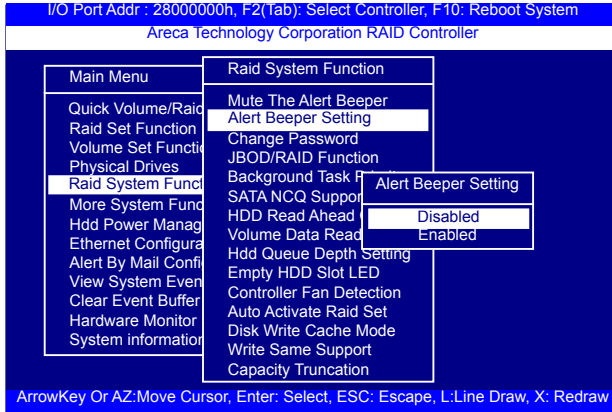

3.7.5.3 Change Password

The manufacture default password is set to 0000. The password option allows user to set or clear the password protection feature. Once the password has been set, the user can monitor and configure the controller only by providing the correct password. This feature is used to protect the internal RAID system from unauthorized access. The controller will check the password only when entering the main menu from the initial screen. The system will automatically go back to the initial screen if it does not receive any command in 5 minutes. To set or change the password, move the cursor to "Raid System Function" screen, press the "Change Password" item. The "Enter New Password" screen will appear. Do not use spaces when you enter the password, If spaces are used, it will lock out the user. To disable the password, only press **Enter** key in both the "Enter New Password" and "Re-Enter New Password" column. The existing password will be cleared. No password checking will occur when entering the main menu.

BIOS CONFIGURATION

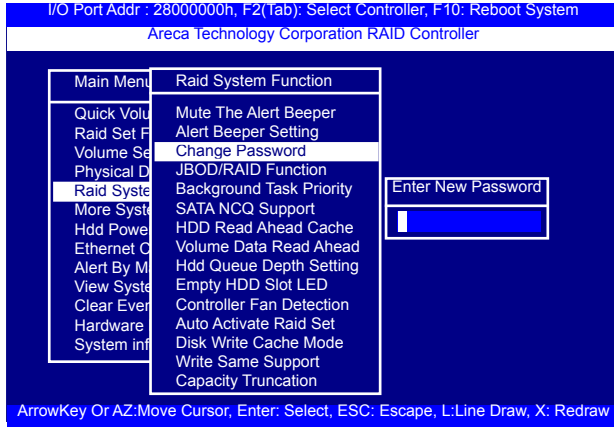

3.7.5.4 JBOD/RAID Function

JBOD is an acronym for "Just a Bunch Of Disk". A group of hard disks in a RAID box are not set up as any type of RAID configuration. All drives are available to the operating system as an individual disk. JBOD does not provide data redundancy. User needs to delete the RAID set, when you want to change the option from the RAID to the JBOD function.

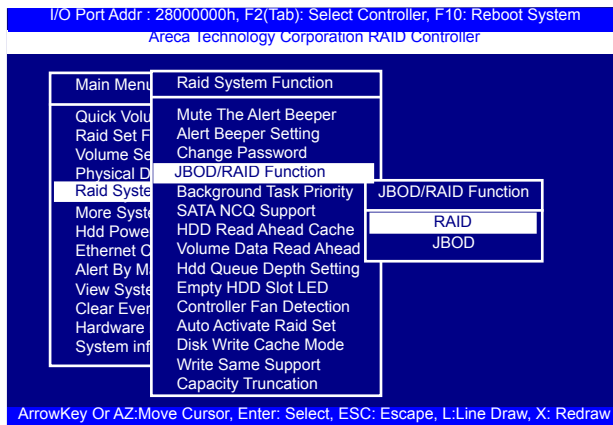

BIOS CONFIGURATION

3.7.5.5 Background Task Priority

The “Background Task Priority” is a relative indication of how much time the controller devotes to a rebuild operation. The SAS RAID controller allows the user to choose the rebuild priority (UltraLow, Low, Normal, High) to balance volume set access and rebuild tasks appropriately.

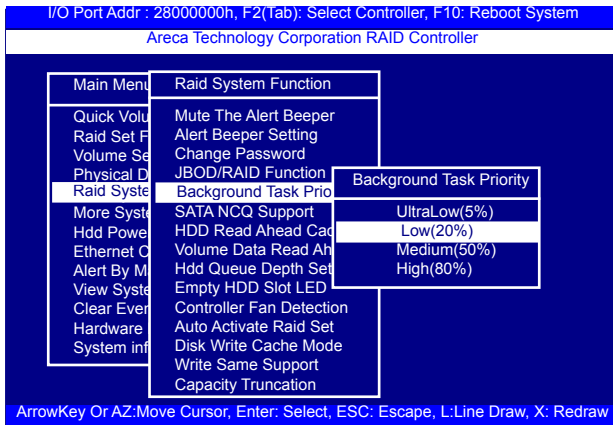

3.7.5.6 SATA NCQ Support

RAID controller supports both SAS and SATA disk drives. The SATA NCQ allows multiple commands to be outstanding within a drive at the same time. Drives that support NCQ have an internal queue where outstanding commands can be dynamically rescheduled or re-ordered, along with the necessary tracking mechanisms for outstanding and completed portions of the workload. The SAS RAID controller allows the user to select the SATA NCQ support: “Enabled” or “Disabled”.

BIOS CONFIGURATION

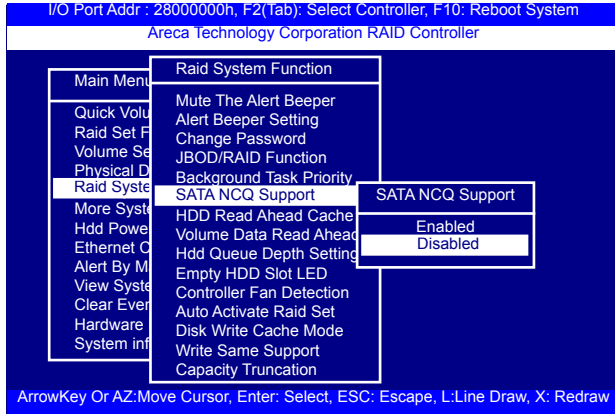

3.7.5.7 HDD Read Ahead Cache

Allow Read Ahead (Default: Enabled)—When "Enabled", the drive's read ahead cache algorithm is used, providing maximum performance under most circumstances.

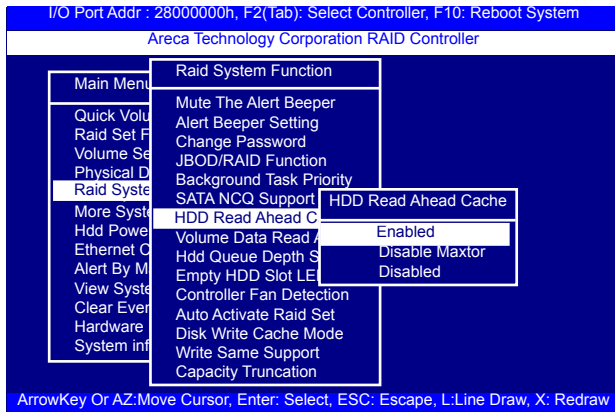

BIOS CONFIGURATION

3.7.5.8 Volume Data Read Ahead

The volume read data ahead parameter specifies the controller firmware algorithms which process the read ahead data blocks from the disk. The "Data Read Ahead" parameter is normal by default. To modify the value, you must set it from the "Raid System Function" using the "Volume Data Read Ahead" option. The default "Normal" option satisfies the performance requirements for a typical volume. The "Disabled" value implies no read ahead. The most efficient value for the controllers depends on your application. The "Aggressive" value is optimal for sequential access but it degrades random access.

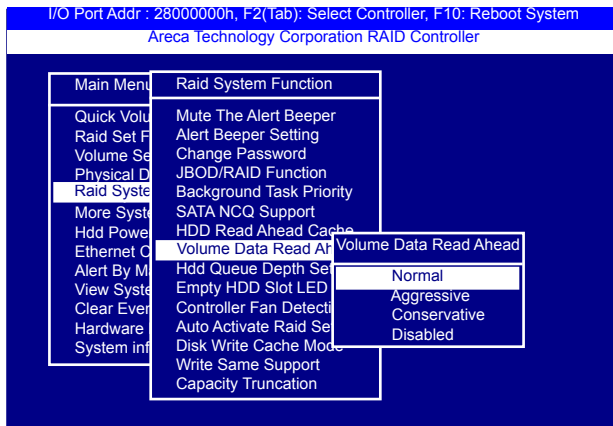

3.7.5.9 Hdd Queue Depth Setting

This parameter is adjusted the queue depth capacity of NCQ (SAS HDD) or Tagged Command Queuing (SAS HDD) which transmits multiple commands to a single target without waiting for the initial command to complete.

BIOS CONFIGURATION

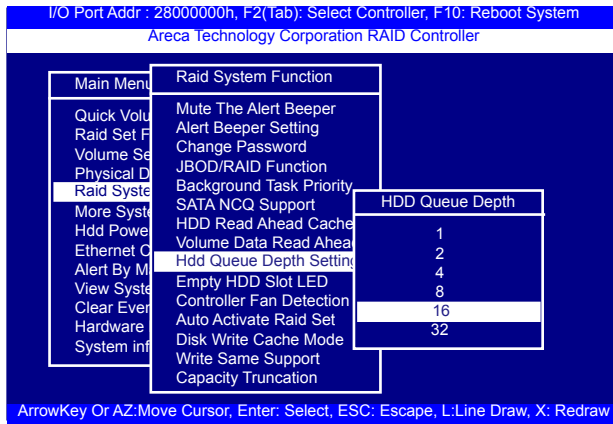

3.7.5.10 Empty HDD Slot LED

The firmware has added the "Empty HDD Slot LED" option to setup the fault LED light "ON" or "OFF" when there is no HDD installed. When each slot has a power LED for the HDD installed identify, user can set this option to "OFF". Choose option "ON", the SAS RAID controller will light the fault LED; if no HDD installed.

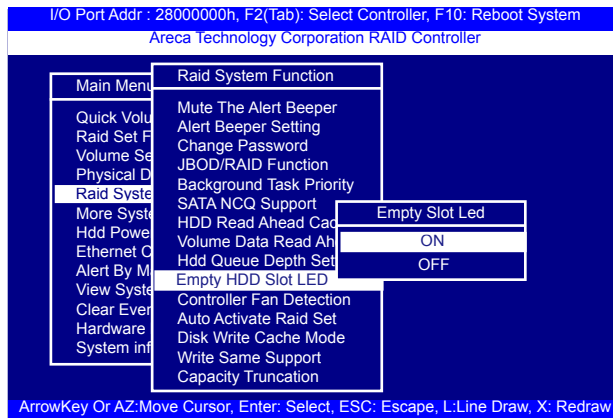

BIOS CONFIGURATION

3.7.5.11 Controller Fan Detection

The ARC-1883ix series incorporate one big passive heatsink attaching a active cooling fan that allows the hot devices such as a ROC and expander chip to keep cool. In addition, newer systems already have enough air flow blowing over the controller. If the systems have provided enough adequate cooling for ROC and expander chip, user can remove the attaching fan on the big passive heat sink.

The "Controller Fan Detection" function is available in the firmware for detecting the cooling fan function on the ROC which uses the active cooling fan. When using the passive heatsink on the controller, disable the "Controller Fan Detection" function through this McBIOS RAID manager setting. The following screen shot shows how to change the McBIOS RAID manager setting to disable the warning beeper function.

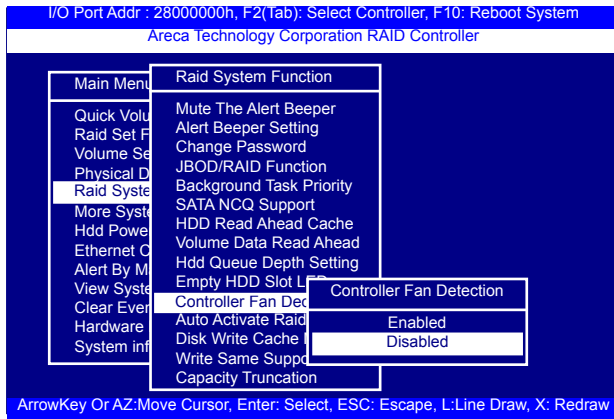

3.7.5.12 Auto Activate Raid Set

When some of the disk drives are removed in power off state or boot up stage, the RAID set state will change to "Incomplete State". But if a user wants to automatically continue to work while the SAS RAID controller is powered on, then user can set the "Auto Activate Raid Set" option to "Enabled". The RAID state will change to "Degraded Mode" while it powers on.

BIOS CONFIGURATION

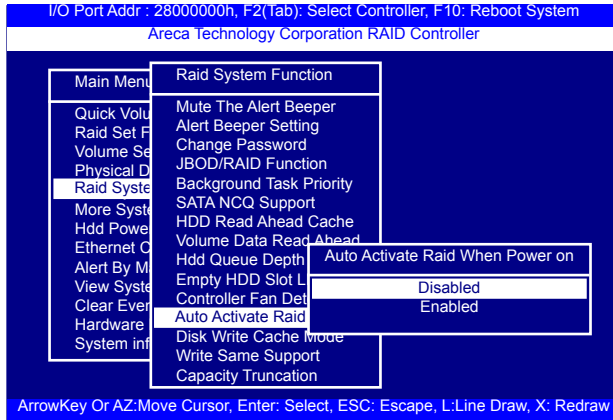

3.7.5.13 Disk Write Cache Mode

User can set the "Disk Write Cache Mode" to Auto, Enabled, or Disabled. "Enabled" increases speed, "Disabled" increases reliability.

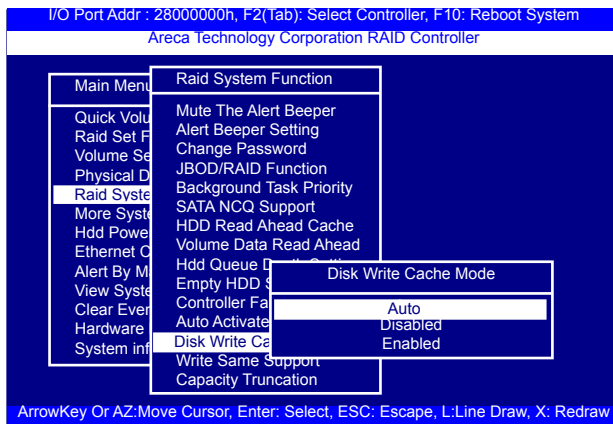

3.7.5.14 Write Same Support

Drives that support the Write Same feature (SCT) can write to multiple drive sectors at once, improving initialization time. To take advantage of this feature, all the drives in the unit must support Write Same. User can set the "SAS And SATA", "SAS Only", "SATA Only" or "Disabled" for the controller initialization.

BIOS CONFIGURATION

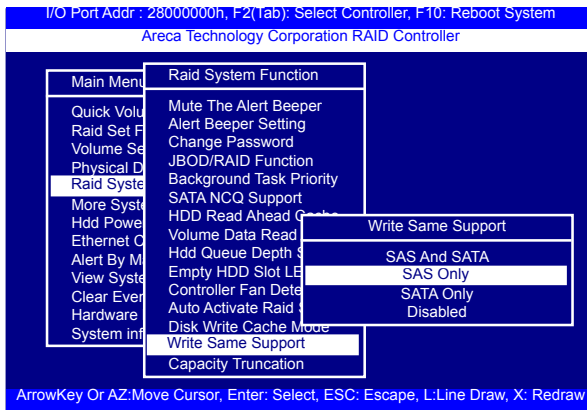

3.7.5.15 Capacity Truncation

Areca RAID controllers use drive truncation so that drives from different vendors are more likely to be usable as spares for one another. Drive truncation slightly decreases the usable capacity of a drive that is used in redundant units. The controller provides three truncation modes in the system configuration: **Multiples Of 10G, Multiples Of 1G and Disabled.**

Multiples Of 10G: If you have 120 GB drives from different vendors; chances are that the capacity varies slightly. For example, one drive might be 123.5 GB, and the other 120 GB. "Multiples Of 10G" truncates the number under tens. This makes the same capacity for both of these drives so that one could replace the other.

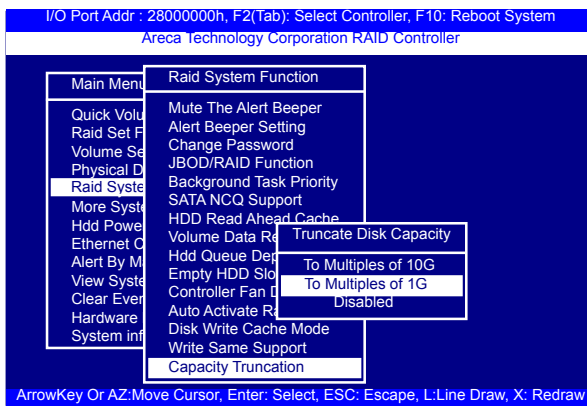

BIOS CONFIGURATION

Multiples Of 1G: If you have 123 GB drives from different vendors; chances are that the capacity varies slightly. For example, one drive might be 123.5 GB, and the other 123.4 GB. "Multiples Of 1G" truncates the fractional part. This makes the same capacity for both of these drives so that one could replace the other.

Disabled: It does not truncate the capacity.

3.7.6 More System Functions

To set the "More System Functions", move the cursor bar to the main menu and select the "More System Functions" item and then press Enter key. The "More System Functions" menu will show multiple items. Move the cursor bar to an item, then press **Enter** key to select the desired function.

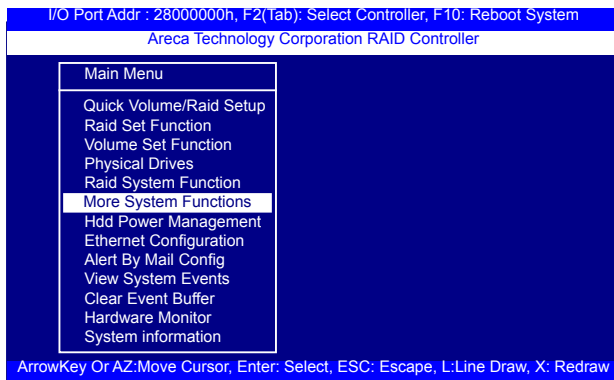

3.7.6.1 Smart Option For HDD

This option is used to increase the reliability of SSDs/HDDs by automatically copying data from a drive with potential to fail to a designated hot spare or newly inserted drive. The options are: "Failed The Drive", "Failed The Drive If Hot Spare Exist", and "Alert Only". The default is "Alert Only".

"Failed The Drive"- controllers kill off the SMART fail drive immediately.

"Failed The Drive If Hot Spare Exist" – controllers kill off the SMART fail disk if hot spare drive is existed.

BIOS CONFIGURATION

“Alert Only” – it will trigger alert when there happens a SMART fail drive.

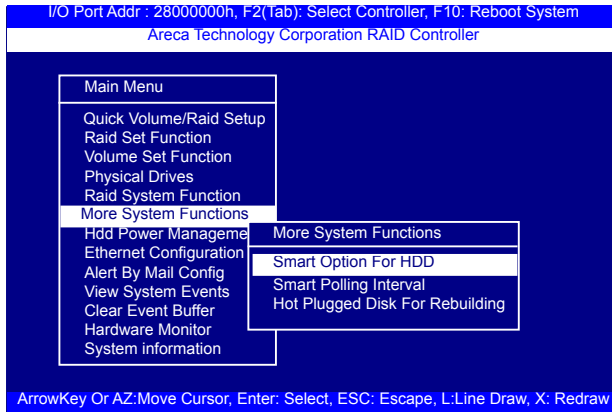

3.7.6.2 Smart Polling Interval

Besides the scheduled volume check, user can define the Smart Pulling Interval to pull the SMART status of each disk. The default is “on demand”.

User can schedule every certain period of time interval to pull the SMART status of each disk. When SMART pulling is executed, disk activity will be temporally halted until the SMART parameter reading is finished. That is why you don't want to set the Interval too frequent. What to use is up to the users to decide based on their applications and experiment results.

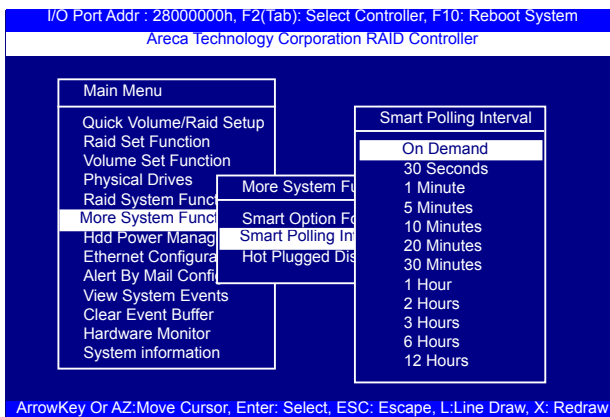

BIOS CONFIGURATION

3.7.6.3 Hot Plugged Disk For Rebuilding

It defines if the RAID array volume should start rebuilding or not when detects a disk is inserted/re-inserted during online. The options are: "Blank Disk Only", "Always", and "Disable". The default is "Blank Disk Only".

"Blank Disk Only"-it will trigger the rebuilding if and only if the inserted disk has not been in the RAID array before, which has no RAID signature on it. So when a previously removed disk is self re-inserted, it won't trigger the degraded RAID array to rebuild, and so that the administrator has a chance to identify this mis-behaving disk and replaces it.

"Always" – it is what it was before. Whenever a disk is inserted/re-inserted whether new or previously existed, it always trigger a rebuilding for the Degraded RAID set/Volume.

"Disable" – it will not trigger rebuilding regardless what sort of disk plugging in. When "Disable" and/or "Blank Disk Only" is selected, the re-inserted/previously removed disk will be identified as a disk in a separate RAID set with duplicated RAIDset# and with all the rest of RAID members missing.

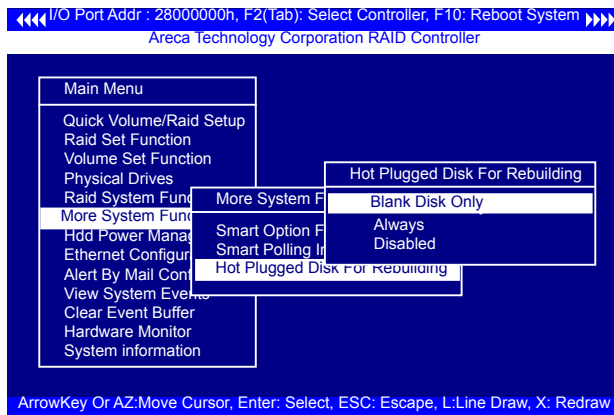

BIOS CONFIGURATION

3.7.7 HDD Power Management

Areca has automated the ability to manage HDD power based on usage patterns. The "HDD Power Management" allows you to choose a "Stagger Power On Control", "Low Power Idle", "Low RPM" and completely "Spins Down Idle HDD". It is designed to reduce power consumption and heat generation on idle drives.

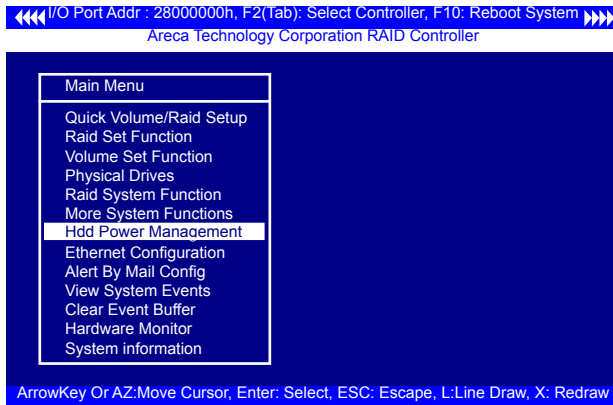

3.7.7.1 Stagger Power On

In a PC system with only one or two drives, the power can supply enough power to spin up both drives simultaneously. But in systems with more than two drives, the startup current from spinning up the drives all at once can overload the power supply, causing damage to the power supply, disk drives and other system components. This damage can be avoided by allowing the host to stagger the spin-up of the drives. The SAS/SATA drives have support stagger spin-up capabilities to boost reliability. Stagger spin-up is a very useful feature for managing multiple disk drives in a storage subsystem. It gives the host the ability to spin up the disk drives sequentially or in groups, allowing the drives to come ready at the optimum time without straining the system power supply. Staggering drive spin-up in a multiple drive environment also avoids the extra cost of a power supply designed to meet short-term startup power demand as well as steady state conditions.

BIOS CONFIGURATION

Areca RAID controller has included the option for customer to select the disk drives sequentially stagger power up value. The values can be selected from 0.4 to 6 seconds per step which powers up one group of drives.

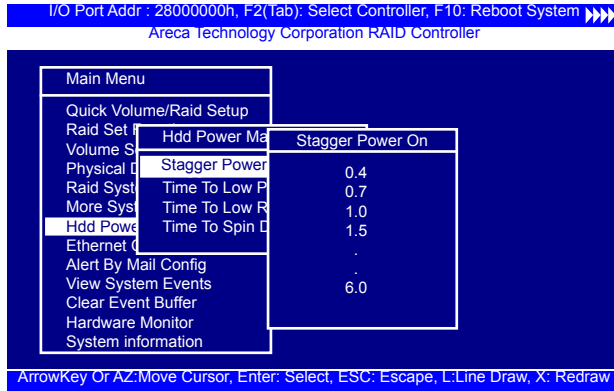

3.7.7.2 Time To Hdd Low Power Idle

This option delivers lower power consumption by automatically unloading recording heads during the setting idle time. The values can be selected "Disabled" or within the range 2 to 7 minutes.

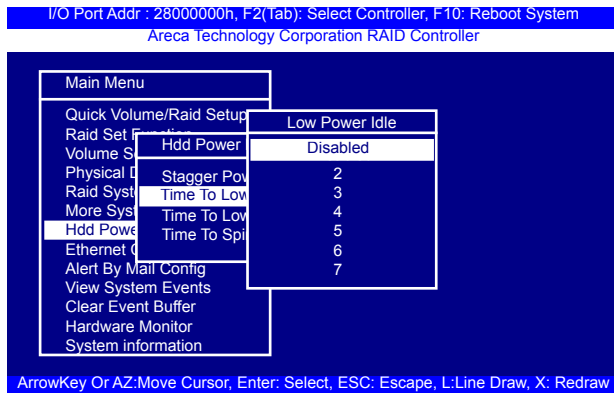

BIOS CONFIGURATION

3.7.7.3 Time To Low RPM Mode

This function can automatically spin disks at lower RPM if there have not been used during the setting idle time. The values can be selected "Disabled" or within the range 10 to 60 minutes.

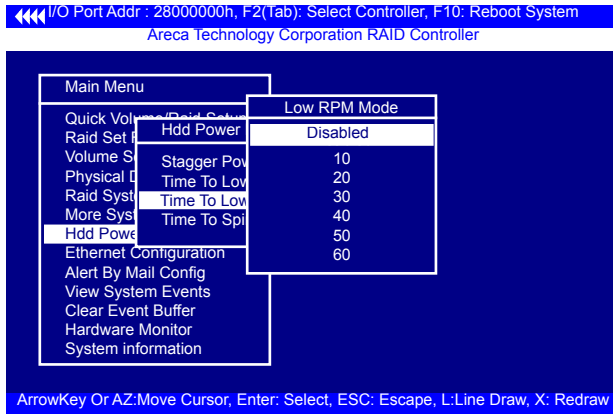

3.7.7.4 Time To Spin Down Idle Hdd

This function can automatically spin down the drive if it hasn't been accessed for a certain amount of time. This value is used by the drive to determine how long to wait (with no disk activity, before turning off the spindle motor to save power). The values can be selected "Disabled" or within the range 1 to 60 minutes.

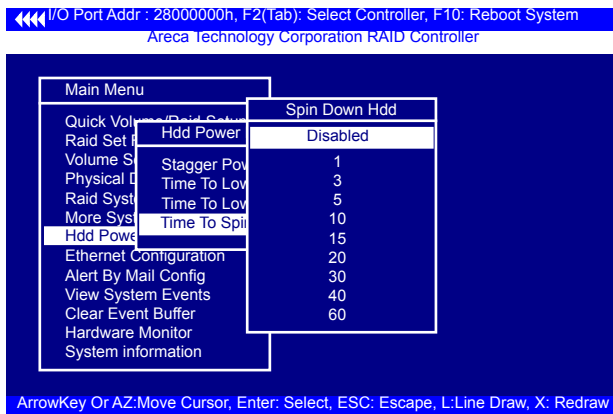

BIOS CONFIGURATION

3.7.8 Ethernet Configuration

Use this feature to set the controller Ethernet port configuration. It is not necessary to create reserved disk space on any hard disk for the Ethernet port and HTTP service to function; these functions are built into the controller firmware. Move the cursor bar to the main menu "Ethernet Configuration Function" item and then press the **Enter** key. The "Ethernet Configuration" menu appears on the screen. Move the cursor bar to an item, and then press **Enter** key to select the desired function.

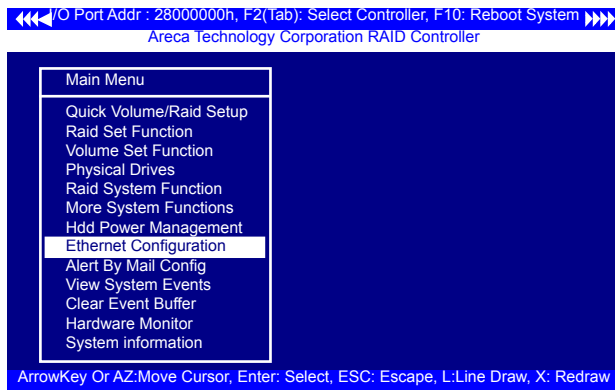

3.7.8.1 DHCP Function

DHCP (Dynamic Host Configuration Protocol) allows network administrators centrally manage and automate the assignment of IP (Internet Protocol) addresses on a computer network. When using the TCP/IP protocol (Internet protocol), it is necessary for a computer to have a unique IP address in order to communicate to other computer systems. Without DHCP, the IP address must be entered manually at each computer system. DHCP lets a network administrator supervise and distribute IP addresses from a central point. The purpose of DHCP is to provide the automatic (dynamic) allocation of IP client configurations for a specific time period (called a lease period) and to minimize the work necessary to administer a large IP network. To manually configure the IP address of the controller, move the cursor bar to DHCP Function item, then press **Enter** key to show the DHCP setting. Select the "Disabled" or "Enabled" option to enable or disable the DHCP function. If DHCP is disabled, it will be neces-

BIOS CONFIGURATION

sary to manually enter a static IP address that does not conflict with other devices on the network.

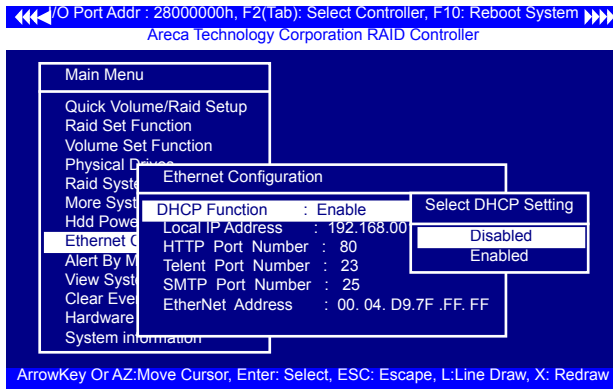

3.7.8.2 Local IP address

If you intend to set up your client computers manually (no DHCP), make sure that the assigned IP address is in the same range as the default router address and that it is unique to your private network. However, it is highly recommend to use DHCP if that option is available on your network. An IP address allocation scheme will reduce the time it takes to set-up client computers and eliminate the possibilities of administrative errors and duplicate addresses. To manually configure the IP address of the controller, move the cursor bar to Local IP address item, then press the **Enter** key to show the default address setting in the RAID controller. You can then reassign the static IP address of the controller.

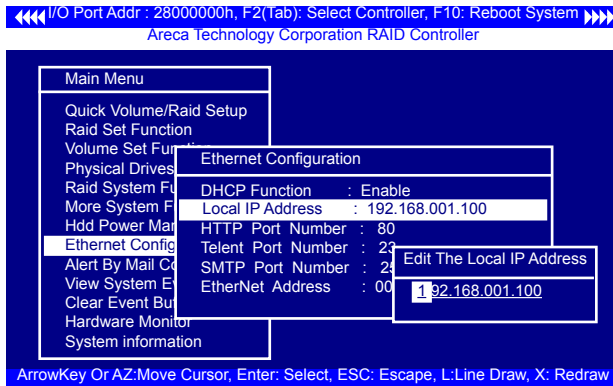

BIOS CONFIGURATION

3.7.8.3 HTTP Port Number

To manually configure the “HTTP Port Number” of the controller, move the cursor bar to “HTTP Port Number” item, then press the **Enter** key to show the default address setting in the RAID controller. Then You can reassign the default “HTTP Port Number” of the controller.

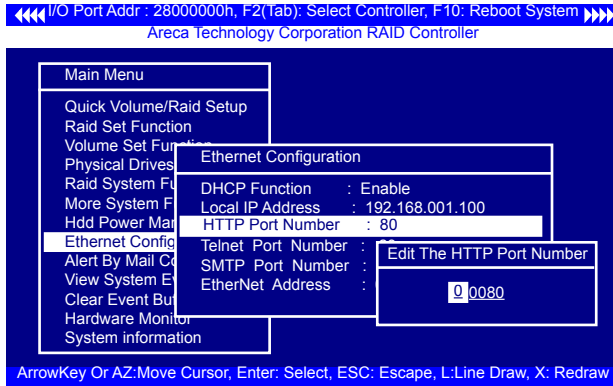

3.7.8.4 Telnet Port Number

To manually configure the “Telnet Port Number” of the controller, move the cursor bar to “Telnet Port Number” item, then press the **Enter** key to show the default address setting in the RAID controller. You can then reassign the default “Telnet Port Number” of the controller.

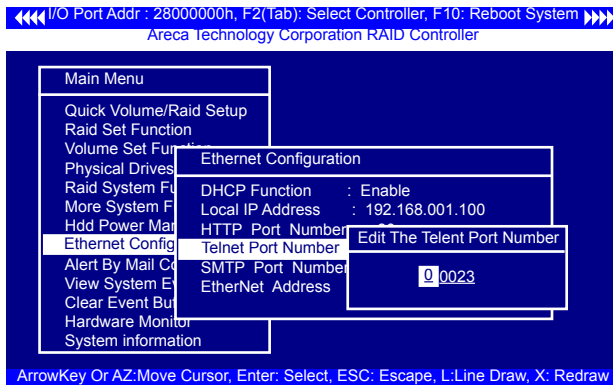

BIOS CONFIGURATION

3.7.8.5 SMTP Port Number

To manually configure the "SMTP Port Number" of the controller, move the cursor bar to the main menu "Ethernet Configuration" function item and then press **Enter** key. The "Ethernet Configuration" menu appears on the screen. Move the cursor bar to "SMTP Port Number" item, then press **Enter** key to show the default address setting in the RAID controller. You can then reassign the default "SMTP Port Number" of the controller.

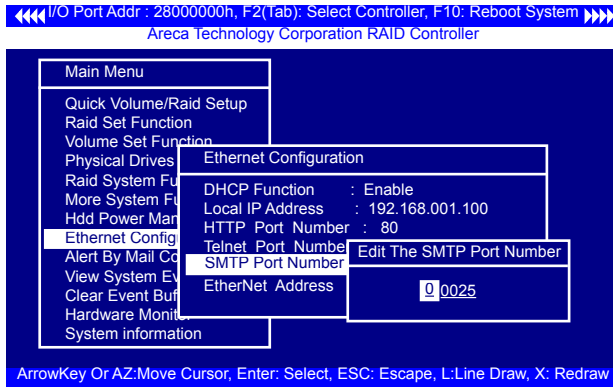

3.7.8.6 Ethernet Address

Each Ethernet port has its unique Mac address, which is also factory assigned. Usually, Ethernet address is used to uniquely identify a port in the Ethernet network.

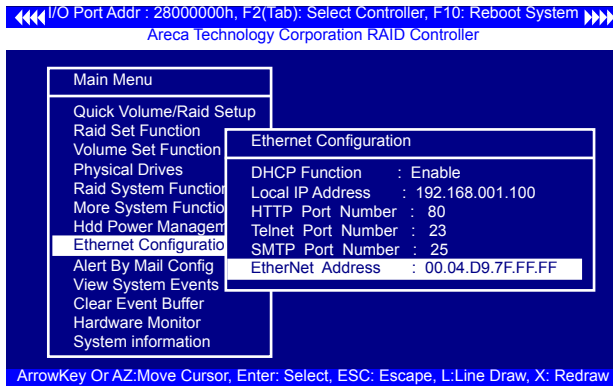

BIOS CONFIGURATION

3.7.9 Alert By Mail Config

To configure the 6Gb/s SAS RAID controller e-mail function, move the cursor bar to the main menu and click on the "Alert By Mail Config" link. The "Alert By Mail Config" menu will show all items. Move the cursor bar to the "Alert By Mail Config" item, then select the desired function.

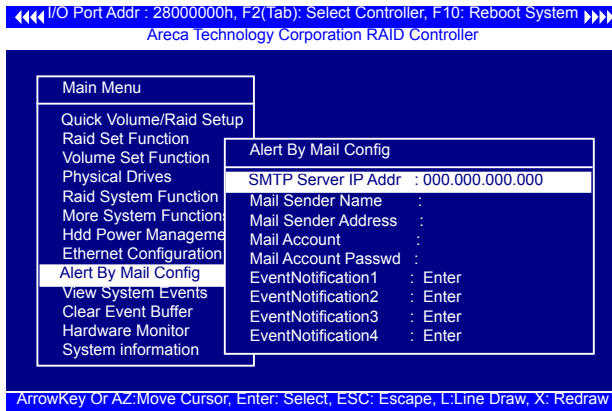

3.7.10 View System Events

To view the SAS RAID controller's system events information, move the cursor bar to the main menu and select the "View System Events" link, then press the **Enter** key. The SAS RAID controller's events screen appear.

Choose this option to view the system events information: Timer, Device, Event type, Elapsed Time, and Errors. The RAID controller does not have a build-in real time clock. The time information is the relative time from the SAS RAID controller powered on.

BIOS CONFIGURATION

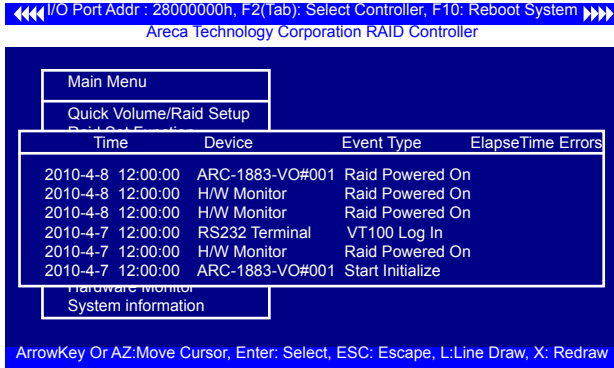

3.7.11 Clear Events Buffer

Use this feature to clear the entire events buffer.

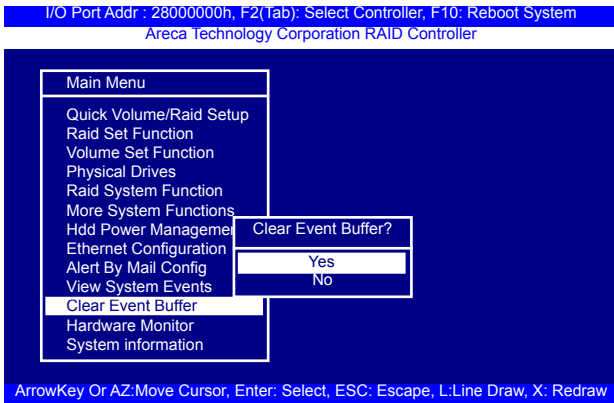

3.7.12 Hardware Monitor

To view the RAID controller's hardware monitor information, move the cursor bar to the main menu and click on the "Hardware Monitor" link. The "Controller H/W Monitor" screen appears. The "Controller H/W Monitor" provides the CPU temperature, controller temperature and voltage of the SAS RAID controller.

BIOS CONFIGURATION

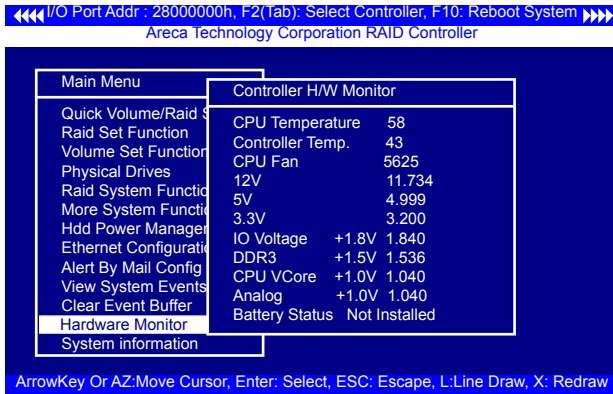

3.7.13 System Information

Choose this option to display controller name, firmware version, BOOT ROM version, SAS firmware version, serial number, main processor, CPU instruction cache and data cache size, system memory, and current IP address. To check the system information, move the cursor bar to "System Information" item, then press **Enter** key. All relevant controller information will be displayed.

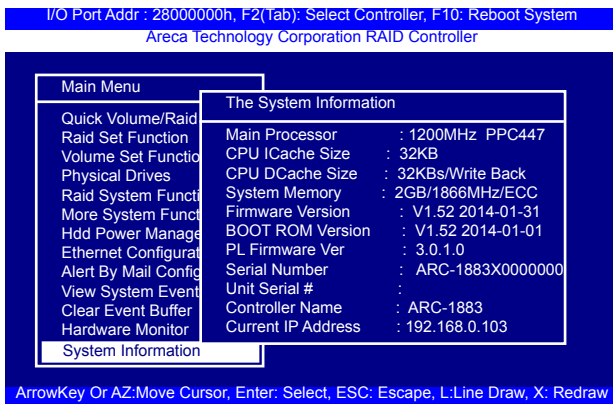

DRIVER INSTALLATION

4. Driver Installation

This chapter describes how to install the SAS RAID controller driver to your operating system. The installation procedures use the following terminology:

Installing operating system on SAS controller's volume

If you have a new drive configuration without an operating system and want to install operating system on a disk drive managed by the SAS RAID controller. The driver installation is a part of the operating system installation.

Installing SAS RAID controller into an existing operating system

The computer has an existing operating system installed and the SAS RAID controller is being installed as a secondary controller.

Have all required system hardware and software components on hand before proceeding with the setup and installation.

Materials required:

- Microsoft Windows, Linux, FreeBSD, Solaris and Mac OS X installation CD
- SAS RAID controller software CD
- SAS RAID controller

4.1 Creating the Driver Diskettes

The software CD disc shipped with the ARC-1883 series 12Gb/s RAID controller is a self-booting CD. In order to create driver diskettes for Windows, Linux, FreeBSD, Solaris and Mac installation drivers, your system is required to support booting from the CD-ROM.

If you do not have the software CD disc with the package, contact your local dealers or you can also download the latest version drivers for Windows 10/8/Server 2012/7/2008/Vista/2003/XP, Linux, FreeBSD, Solaris and Mac OS X from the Areca web site at <http://www.areca.com.tw>

DRIVER INSTALLATION

These driver diskettes are intended for use with new operating system installations. For Windows 10/8/Server 2012/7/2008/Vista, you can copy the Windows driver file to USB device and installed from it. Determine the correct kernel version and identify which diskette images contain drivers for that kernel. If the driver file ends in .img, you can also create the appropriate driver diskette using "dd" utility. The following steps are required to create the driver diskettes:

1. The computer system BIOS must be set to boot-up from the CDROM.
2. Insert the ARC-1883 software driver CD disc into the CD-ROM drive.
3. The system will boot-up from CD-ROM Drive; to create the driver diskettes, select the "SAS RAID Controller Driver Diskette Make Utility", and a screen with several choices will be displayed.
4. Move the highlight bar to the "Create Driver Disk" entry and press **Enter**.
5. The screen queries the ARC-1883 SAS RAID controllers support driver database and displays a list of available drivers. Move the highlight bar to the correct driver entry and press **Enter** key to select.
6. The next screen will show "Please insert a formatted diskette into drive A:!! Press any key to continue". Insert the formatted diskette in drive "A" and press any key to continue.
7. The window will display the driver building message: "Now is writing to Cylinder..." as it copies the image file from the CDROM to driver diskette.
8. The "Write Complete !!" message will display when the driver diskette ready.

The driver diskette is made now. Proceed to the following instruction for installation procedures.

DRIVER INSTALLATION

4.2 Driver Installation for Windows

The SAS RAID controller can be used with Microsoft Windows 10/8/Server 2012/7/2008/Vista/XP/2003 with StorPort Drivers.

4.2.1 Installing Windows on a RAID Volume

For completed details on installing Windows, see the Windows User's Manual. The following procedures detail installing the SAS RAID controller driver while installing Windows 10/8/Server 2012/7/2008/Vista/XP/2003. Have your bootable Microsoft Windows CD and follow the required procedure below to install SAS RAID controller:

1. Make sure you follow the instructions in Chapter 2 "Hardware Installation" to install the controller and connect the disk drives or enclosure.
2. Start the system and then press **Tab** or **F6** to access the Mc BIOS RAID manager. Use the McBIOS RAID manager to create the RAID set and volume set to which you will install Windows. For details, see Chapter 3 "McBIOS RAID manager". Once a volume set is created and configured, continue with next step to install the operating system.
3. Insert the Windows setup CD and reboot the system to begin the Windows installation.
4. Follow the on-screen instructions to begin the Windows installation.
5. When prompted to specify a location for Windows, select "**Load Driver**".
6. Insert the USB driver disk or floppy drive, browse to the driver location, then click "**OK**".
7. Window will check the floppy; select the correct card and CPU type for your hardware from the listing and press "**Next**" to install it.

DRIVER INSTALLATION

8. Click on "**Next**" again to accept the default partition configuration, or refer to your Windows documentation to configure partitions manually.
9. From this point on, simply follow the Microsoft Windows installation procedure. Follow the on-screen instructions, responding as needed, to complete the installation.
10. After the installation is completed, reboot the system to load the new driver/operating system.
11. See Chapter 5 in this manual to customize your RAID volume sets using McRAID storage manager.

After you finish creating additional volume, the following steps show how to make any new volumes or independent disks accessible to Windows.

- (a). Click "**Start**" => right-click "**Computer**" and select "**Manage**".
- (b). Click "**Disk Management**" in the left pane.
- (c). Scroll down to the bottom of the middle pane.
Windows will display a list of new drives attached to your system with a label such as "Disk 1" or "Disk 2", etc.
- (d). Right-click on the drive you want to partition and then again to format it
- (e). Once it's formatted, Windows automatically assigns the next available drive letter to it and then it will appear in Windows Explorer.

4.2.2 Installing Controller on an Existing Windows

In this scenario, you are installing the controller in an existing Windows system. To install the driver:

1. Follow the instructions in Chapter 2, the Hardware Installation

DRIVER INSTALLATION

Chapter, to install the controller and connect the disk drives or enclosure.

2. Start the system and then press **Tab** or **F6** to enter the controller McBIOS RAID manager. Use the configuration utility to create the RAID set and volume set. For details, see Chapter 3, McBIOS RAID Manager. Once a volume set is created and configured, continue with installation of the driver.
3. Re-Boot Windows and the OS will recognize the SAS RAID controller and launch the "Found New Hardware Wizard", this guides you in installing the SAS RAID driver.
4. The Windows will pop-up and provide a choice of how to proceed. so that you can choose a specific driver.
5. When the next screen queries the user about utilizing the currently installed driver, click on the "**Have Disk**" button.
6. Insert the SAS RAID controller driver media to locate the correct path. Click on the "**Next**" button.
7. Windows automatically copies the appropriate driver files and rebuilds its driver database.
8. The summary screen appears; click on the "**close**" button.
9. Restart the computer to load the new drivers.
10. See Chapter 5 in this manual for information on customizing your RAID volumes using McRAID storage manager.

After you finish creating additional volume, the following steps show how to make any new volumes or independent disks accessible to Windows.

- (a). Click "**Start**" ==> right-click "**Computer**" and select "**Manage**".
- (b). Click "**Disk Management**" in the left pane.

DRIVER INSTALLATION

- (c). Scroll down to the bottom of the middle pane. Windows will display a list of new drives attached to your system with a label such as "Disk 1" or "Disk 2", etc.
- (d). Right-click on the drive you want to partition and then again to format it
- (e). Once it's formatted, Windows automatically assigns the next available drive letter to it and then it will appear in Windows Explorer.

4.2.3 Uninstall controller from Windows

To remove the SAS RAID controller driver from the Windows system, follow the instructions below.

1. Ensure that you have closed all applications and are logged in with administrative rights.
2. Open "Control Panel" and start the "Add/Remove Program" icon and uninstall and software for the SAS RAID controller.
3. Go to "Control Panel" and select "System". Select the "Hardware" tab and then click the "Device Manager" button. In device manager, expand the "SCSI and RAID Controllers" section. Right click on the SAS RAID controller and select "Uninstall".
4. Click **Yes** to confirm removing the SAS RAID driver. The prompt to restart the system will then be displayed.

4.3 Driver Installation for Linux

This chapter describes how to install the SAS RAID controller driver to Red Hat Linux, SuSE and other versions of Linux. Before installing the SAS RAID driver to the Linux, complete the following actions:

1. Install and configure the controller and hard disk drives according to the instructions in Chapter 2 Hardware Installation.

DRIVER INSTALLATION

2. Start the system and then press **Tab** or **F6** to enter the McBIOS RAID manager configuration utility. Using the McBIOS RAID manager to create the RAID set and volume set. For details, see Chapter 3, McBIOS RAID Manager.

If you are using a Linux distribution for which there is not a compiled driver available from Areca, you can copy the source from the SAS software CD or download the source from the Areca website and compile a new driver.

Compiled and tested drivers for Red Hat and SuSE Linux are included on the shipped CD. You can download updated versions of compiled and tested drivers for RedHat or SuSE Linux from the Areca web site at <http://www.areca.com.tw>. Included in these downloads is the Linux driver source, which can be used to compile the updated version driver for RedHat, SuSE and other versions of Linux. Please refer to the "readme.txt" file on the included SAS RAID controller CD or website to make driver diskette and install driver to the system.

4.4 Driver Installation for FreeBSD

This chapter describes how to install the SAS RAID controller driver to FreeBSD. Before installing the SAS RAID driver to FreeBSD, complete following actions:

1. Install and configure the controller and hard disk drives according to the instructions in Chapter 2, Hardware Installation.
2. Start the system and then press **Tab** or **F6** to enter the McBIOS RAID Manager configuration utility. Use the McBIOS RAID manager to create the RAID set and volume set. For details, see Chapter 3, McBIOS RAID Manager.

The supplied software CD that came with the SAS RAID controller includes compiled and tested drivers for FreeBSD 7.x (7.2 and onwards), 8.x (8.0 and onwards) and 9.x (9.0 and onwards). To check if a more current version driver is available, please see the Areca web site at <http://www.areca.com.tw>.

Please refer to the "readme.txt" file on the SAS RAID controller

DRIVER INSTALLATION

software CD or website to make driver diskette and install driver to the system.

4.5 Driver Installation for Solaris

This chapter describes how to install the SAS RAID controller driver to Solaris. Before installing the SAS RAID driver to Solaris, complete following actions:

1. Install and configure the controller and hard disk drives according to the instructions in Chapter 2, Hardware Installation.
2. Start the system and then press **Tab** or **F6** to enter the McBIOS RAID Manager configuration utility. Use the McBIOS RAID manager to create the RAID set and volume set. For details, see Chapter 3, McBIOS RAID Manager.

The supplied software CD that came with the SAS RAID controller includes compiled and tested drivers for Solaris 10/11 x86/x86_64. Please refer to the "readme.txt" file on the software CD or website: <http://www.areca.com.tw> to make driver diskette and install driver to the system.

4.6 Driver Installation for Mac OS X

After hardware installation, the SAS/SATA disk drives connected to the SAS RAID controller must be configured and the volume set units initialized by the controller before they are ready to use by the system.

4.6.1 Installation Procedures

This section describes detailed instructions for installing the Areca Mac driver & utility for the ARC-1883 series on your Intel_based Mac Pro. You must have administrative level permissions to install Mac driver & utility. You can use the MRAID installer to install Mac driver & utility (MRAID) at once or "Custom" to install special components.

To follow the process to install driver & utility on Intel-based Mac as below:

DRIVER INSTALLATION

1. Insert the Areca Software CD that came with your Areca SAS RAID controller.
2. Double-click on the "install_mr raid.zip" file that resides at <CD-ROM>\packages\MacOS to add the installer on the Finder.
3. Launch the installer by double-clicking the install_mr raid on the Finder.
4. Follow the installer on-screen steps, responding as needed, to complete the Areca driver and MRAID (ArcHTTP and CLI utility) installation.



- **Driver** is required for the operating system to be able to interact with the Areca RAID controller.

Important:

Be sure to update the ArcMSR.kext driver shipping with Mac OS X to V1.3.7 or later from the software CD or from the Areca website.

- **ArcHTTP** has to be installed for GUI RAID console (MRAID storage manager) to run. It also runs as a service or daemon in the background that allows capturing of events for mail and SNMP traps notification. Refer to the section 5.6 ArcHTTP Configuration, for details about the mail and SNMP traps configuration.
- **Command Line Interface (CLI)** lets you set up and manage RAID controller through a command line interface. CLI performs many tasks at the command line. You can download

DRIVER INSTALLATION

CLI manual from Areca website or software CD <CDROM>\DOCS directory.

5. A reboot is required to complete the installation (This will start the ArchHTTP so RAID Console can be used).
6. Normally ArchHTTP64 and CLI are installed at the same time on SAS RAID controller. Once ArchHTTP and CLI have been installed, the ArchHTTP background task automatically starts each time when you start your computer.

There is one "MRAID" icon showing on your desktop. Double-click on the "MRAID" icon to locate your ArchHTTP utility and CLI program file folder.

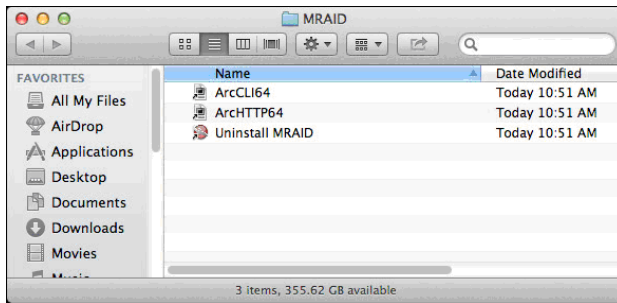

When you double-click on the "ArcHTTP64", it shows all RAID storages available on the system and create an individual RAID storage icon located on left column of the "ArchHTTP Configurations" screen.

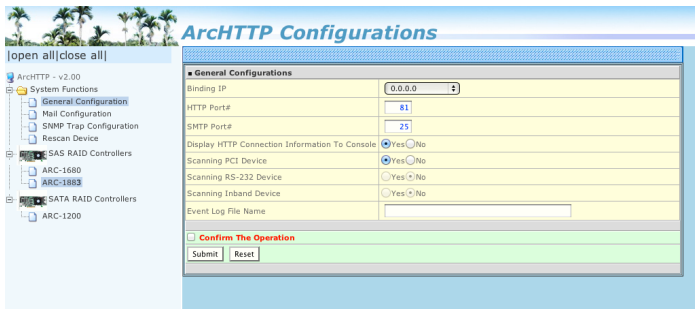

DRIVER INSTALLATION

Locate "ARC-1883 Web Management" and launch the selected McRAID storage manager. Enter RAID storage default User Name "admin" and the Password "0000" when the login page prompted for it. After logging in, the McRAID storage manager process starts.

If there is any RAID adapter missed on the system start-up, you can use the "Rescan Device" function. See chapter 5 in this manual for information on customizing your RAID volumes using McRAID storage manager.

4.6.2 Making Volume Sets Available to Mac OS X

When you create a volume through McRAID storage manager, the Mac OS X recognizes that a new disk is avail, and displays a message asking what you next want to do. If the message does not show up, start the "Disk Utility" manually from the "Finder", use the "Go" menu and open the "Utilities" folder. Double-click on the "Disk Utility" program. Follow the on-screen prompts to create a volume set and to assign a disk drive letter.

To initialize and partition your unit

1. When the Disk Utility window opens, find and select the desired drive in the sidebar that represents your RAID storage and click on the "Partition" button.
2. In the Partition Layout column, click on the "Current" to show the drop-down menu and select the number of partitions that you want your RAID storage to have. Each partition will appear as a separate drive on your computer.

DRIVER INSTALLATION

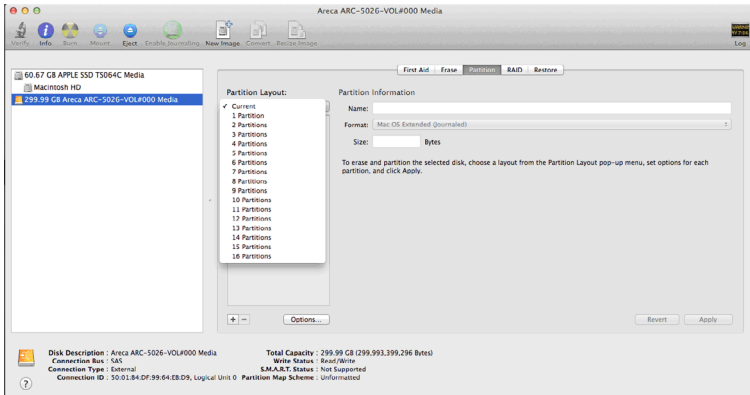

3. Specify your Partition Information, Option setting and click on the "Apply" button.

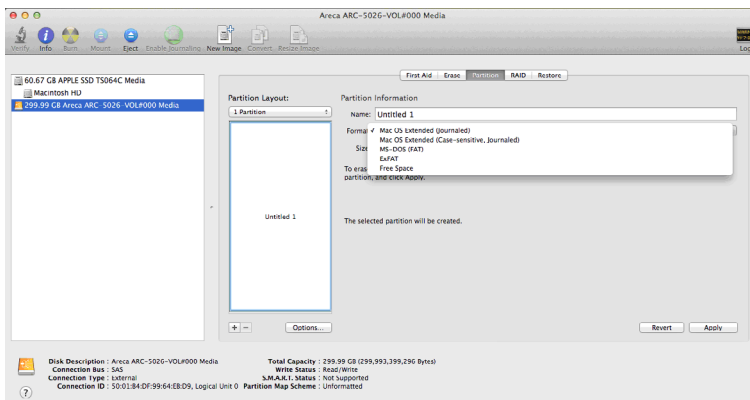

If you're not sure which format to use, choose Mac OS X Extended (Journaled).

4. When a message asks you to confirm you want to partition the disk, click on the "Partition" button. This may take a couple of minutes, depending on the size of the drives in your RAID storage. When the partitioning is complete, icons for each new partition show up on your desktop. They are now ready to use.

ARCHTTP PROXY SERVER INSTALLATION

5. ArchHTTP Proxy Server Installation

Overview

After hardware installation, the SAS/SATA disk drives connected to the SAS RAID controller must be configured and the volume set units initialized before they are ready to use.

The user interface for these tasks can be accessed through the built-in configuration that resides in the controller's firmware. It provides complete control and management of the controller and disk arrays, eliminating the need for additional hardware or software.

In addition, a software utility to configure the SAS RAID controller is provided on the software CD delivered with SAS RAID controller. This software CD contains the software utility that can monitor, test, and support the SAS RAID controller. The software utility and McRAID storage manager can configure and monitor the SAS RAID controller via ArchHTTP proxy server interface. The following table outlines their functions:

Configuration Utility	Operating System Supported
McBIOS RAID Manager	OS-Independent
McRAID Storage Manager (Via ArchHTTP proxy server)	Windows, Linux, FreeBSD, Solaris and Mac OS X
SAP Monitor (Single Admin Portal to scan for multiple RAID units in the network, Via ArchHTTP proxy server)	Windows

The HTTP management software (ArchHTTP) runs as a service or daemon, and have it automatically start the proxy for all controllers found. This way the controller can be managed remotely without having to sign in the server. The HTTP management software (ArchHTTP) also has integrated the email notification and SNMP extension agent. The email notification can be configured in local or remote standard web browser.

Note:

If your controllers have onboard LAN port, you do not need to install ArchHTTP proxy server, you can use McRAID storage manager directly.

ARCHTTP PROXY SERVER INSTALLATION

5.1 For Windows

You must have administrative level permissions to install SAS RAID software. This procedure assumes that the SAS RAID hardware and Windows are installed and operational in your system.

Screen captures in this section are taken from a Windows XP installation. If you are running another version of Windows, your installation screen may look different, but the ArchHTTP proxy server installation is essentially the same.

1. Insert the RAID controller software CD in the CD-ROM drive.
2. Run the install.exe file that resides at: <CD-ROM>\PACKAGES\Windows\http directory on the CD-ROM.
3. The screen shows ArchHTTP installation introduction.

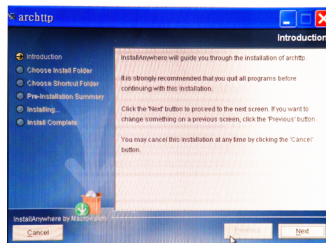

Follow the on-screen prompts to complete ArchHTTP proxy server software installation. A program bar appears that measures the progress of the ArchHTTP proxy server setup. When this screen completes, you have completed the ArchHTTP proxy server software setup.

4. After a successful installation, press "Done" to quit the installer.

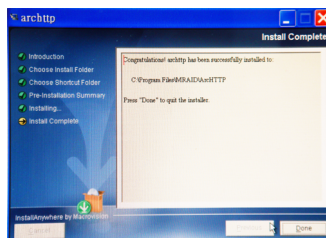

ARCHTTP PROXY SERVER INSTALLATION

There "Areca RAID Controller" icon bar window start appearing in the taskbar, double-click to launch the ArchHTTP Configuration screen. Or click on the "Start" button in the Windows task bar and then click on the "Program", select the "McRAID" and run " ArchHTTP proxy server". The ArchHTTP Configurations dialog box appears.

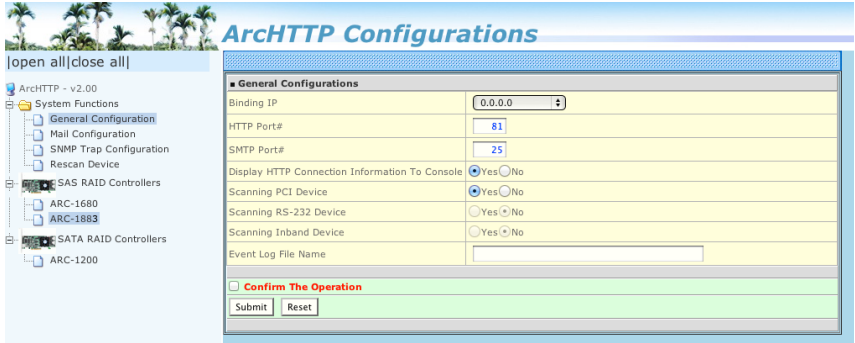

It shows all RAID adapters available on the system and creates an individual adapter icon located on left column of the "ArchHTTP Configurations" screen. This adapter icon is for user to launch the selected RAID adapter web browser RAID manager.

1. See the next chapter detailing the McRAID Storage Manager to customize your RAID volume set.
2. If you need to configure the "System Function" of ArchHTTP, please refer to section 5.6 ArchHTTP Configuration.

5.2 For Linux

You should have administrative level permissions to install SAS RAID software. This procedure assumes that the SAS RAID hardware and Linux are installed and operational in your system.

The following installation procedure explains how to install the SAS RAID software for Linux. The ArchHTTP proxy server is provided on the software CD delivered with SAS RAID controller card or download from the www.areca.com.tw. The firmware embedded McRAID storage manager can configure and monitor the SAS RAID controller via ArchHTTP proxy server.

ARCHTTP PROXY SERVER INSTALLATION

1. Login as root. Copy the ArchHTTP file to a local directory.
 - (a). Insert the SAS RAID controller CD in the CD-ROM drive.
 - (b). Copy <CD-ROM>\PACKAGES\Linux\http directory to local (Ex:/usr/local/sbin). or
 - (c). Download from the www.areca.com.tw or from the email attachment.
2. You must have administrative level permissions to install SAS RAID controller ArchHTTP proxy server software. This procedure assumes that the SAS RAID hardware and driver are installed and operational in your system.

The following details are the installation procedure of the SAS RAID controller for Linux ArchHTTP proxy server software.

- (a). Run the ArchHTTP proxy server by using the following command:
Usage: ./archttp32 (TCP_PORT) or ./archttp64 (TCP_PORT).
It depends on your OS version.
Parameters: TCP_PORT value= 1~65535 (If TCP_PORT assigned, ArchHTTP will start from this port. Otherwise, it will use the setting in the archttpsrv.conf or default 81). This is the port address assigning for the ArchHTTP configuration (Cfg Assistant). Such as: archttp64 1553
- (b). ArchHTTP server console started, Controller card detected then ArchHTTP proxy server screen appears.

Copyright (c) 2004 Areca, Inc. All Rights Reserved.
Areca HTTP proxy server V2.4.0 for Areca RAID controllers.

Controller(s) list

```
-----  
Cfg Assistant : Listen to port[1553].  
Controller[1](PCI) : Listen to port[1554].  
Binding IP:[0.0.0.0]  
Note: IP[0.0.0.0] stands for any ip bound to this host.  
-----
```

```
#####
```

ARCHTTP PROXY SERVER INSTALLATION

Press CTRL-C to exit program!!

#####

Controller [1] Http: New client [9] accepted

Controller [1] Http: New Recv 243 bytes

Controller [1] Http: Send [174] bytes back to the client

- (c). If you need the "Cfg Assistant", please refer to section 5.6 ArcHTTP Configuration.
- (d). For detailing about McRAID storage manager to customize your RAID volume set is discussed in Chapter 6.

For Mozilla user:

Because our management need Java support, so user may need upgrade to version 1.6 or later.

5.3 For FreeBSD

You must have administrative level permissions to install SAS RAID software. This procedure assumes that the SAS RAID hardware and FreeBSD are installed and operational in your system. The following installation procedure explains how to install the SAS RAID software for FreeBSD.

1. Insert the SAS RAID controller software CD in the CD-ROM drive.
2. Login as root. Copy <CD-ROM>\PACKAGES\FreeBSD\http ArchHTTP file to a local directory. The next steps are same as Linux. Please see section 5.2 For Linux.

5.4 For Solaris 10

You must have administrative level permissions to install SAS RAID software. This procedure assumes that the SAS RAID hardware and Solaris are installed and operational in your system. The following installation procedure explains how to install the SAS RAID software for Solaris.

ARCHTTP PROXY SERVER INSTALLATION

1. Insert the SAS RAID controller software CD in the CD-ROM drive.
2. Login as root. Copy <CD-ROM>\PACKAGES\Solaris\http ArchTTP file to a local directory. The next steps are same as Linux. Please see section 5.2 For Linux.

5.5 For Mac OS X

The firmware embedded McRAID storage manager can configure and monitor the SAS RAID controller via ArchTTP proxy server. The ArchTTP proxy server for Mac OS X has combined with the CLI and driver on the install_mraid installer, please refer to Chapter 4.6 Driver Installation for Mac OS X.

5.6 ArchTTP Configuration

The ArchTTP proxy server will automatically assign one additional port for setup its configuration. If you want to change the "archttp-srv.conf" setting up of ArchTTP proxy server configuration, for example: General Configuration, Mail Configuration, and SNMP Configuration, please start Web Browser `http://localhost: Cfg Assistant`. Such as `http://localhost: 81`. The port number for the first controller McRAID storage manager is ArchTTP proxy server configuration port number plus 1.

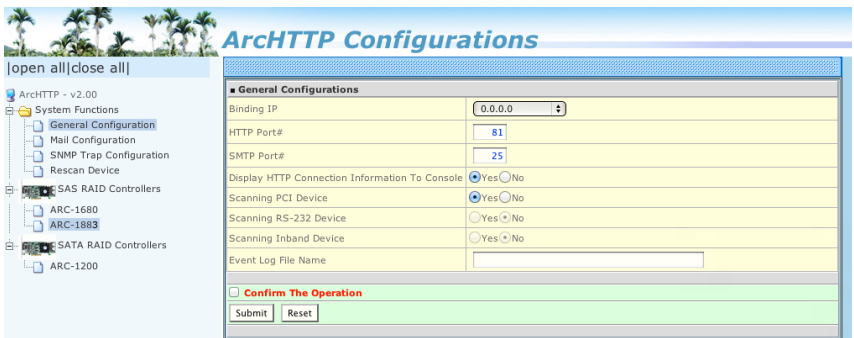

● **General Configuration:**

Binding IP: Restrict ArchTTP proxy server to bind only single interface (If more than one physical network in the server).

ARCHTTP PROXY SERVER INSTALLATION

HTTP Port#: Value 1~65535

Display HTTP Connection Information To Console: Select "Yes" to show Http send bytes and receive bytes information in the console.

Scanning PCI Device: Select "Yes" for ARC-1883 series controller

Scanning RS-232 Device: No

Scanning Inband Device: No

● **Mail (alert by Mail) Configuration:**

Many users require that email notifications be sent to the appropriate administrators when an alert is detected. To set up your mail servers, click on the "Mail Configuration" link. The "SMTP Server Configurations" allows you to define settings for your mail server. This setup screen is shown as below:

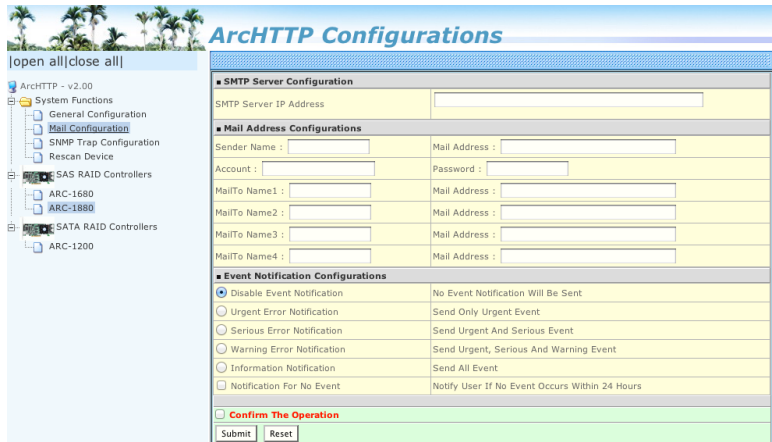

The screenshot displays the "ArchHTTP Configurations" web interface. On the left is a navigation tree with "Mail Configuration" selected. The main content area is titled "SMTP Server Configuration" and includes the following sections:

- SMTP Server IP Address:** A text input field.
- Mail Address Configurations:** A table with four rows for MailTo Name1 through MailTo Name4. Each row contains fields for "Sender Name", "Mail Address", "Account", and "Password".
- Event Notification Configurations:** A table with radio buttons for "Disable Event Notification", "Urgent Error Notification", "Serious Error Notification", "Warning Error Notification", "Information Notification", and "Notification For No Event". Corresponding actions are listed in the right column, such as "No Event Notification Will Be Sent", "Send Only Urgent Event", "Send Urgent And Serious Event", "Send Urgent, Serious And Warning Event", "Send All Event", and "Notify User If No Event Occurs Within 24 Hours".
- Confirm The Operation:** A section with "Submit" and "Reset" buttons.

The following article describes a best practice methodology for setting this up in the "SMTP Server Configurations".

1. SMTP Server Configuration:

SMTP Server IP Address: Enter IP address of the SMTP server to configure your mail program correctly.

Ex: 192.168.0.2.

2. Mail Address Configurations:

Sender Name: This is the sender name that the e-mail alerts will appear to be coming from.

Ex: RaidController_1.

ARCHTTP PROXY SERVER INSTALLATION

Mail address: This is the mail address that the e-mail alerts will appear to be coming from, but don't type IP to replace domain name.

Ex: RaidController_1@areca.com.tw.

Account: Enter the valid account if your SMTP mail server requires authentication.

Password: Enter the valid password if your SMTP mail server requires authentication.

3. Event Notification Configurations:

This step involves setting up of notification rules. Notification rules instruct ArchHTTP on the notifications that should be sent when certain types of alerts are detected.

MailTo Name: Enter the alert receiver name that will be shown in the outgoing mail.

Mail Address: Enter the receiver's e-mail address. This is the address you want the e-mail alerts sent to.

Ex: admin@areca.com.tw.

According to your requirement, set the corresponding event level:

Disable Event Notification: No event notification will be sent.

Urgent Error Notification: Send only urgent events.

Serious Error Notification: Send urgent and serious events.

Warning Error Notification: Send urgent, serious and warning events.

Information Notification: Send all events.

Notification For No Event: Notify user if no event occurs within 24 hours.

• SNMP Traps Configuration:

This section discusses how to enable the SNMP traps on your RAID storage, and how to control the sending of SNMP traps from the ArchHTTP. To send the SNMP traps to client SNMP manager such as Net-SNMP manager using the IP address assigned to the operating system, you can simply use the SNMP function on the ArchHTTP. The ArchHTTP only provides one direction to send the trap to the SNMP manager without needing to install the SNMP extension agent on the host. If SNMP manager requests to query the SNMP information from RAID storage, please refer the Appendix D "SNMP Operation & Installation".

ARCHTTP PROXY SERVER INSTALLATION

To set up SNMP traps sending function, click on the "SNMP Configuration" link. SNMP Traps Configurations are set up on this page. This setup screen is shown as below:
The following article describes a best practice methodology for setting this up in the "SNMP Traps Configurations".

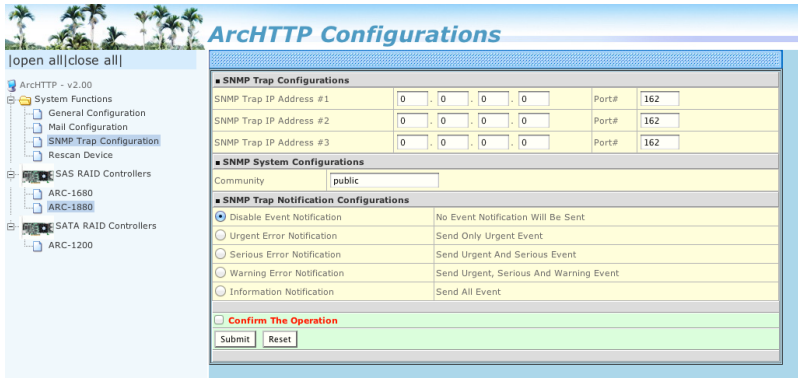

1. SNMP Trap Configurations

Enter the SNMP trap IP address.

2. SNMP System Configurations

Community name acts as a password to screen accesses to the SNMP agent of a particular network device. Type the community names of the SNMP agent in this field. Most network devices use "public" as default of their community names. This value is case-sensitive.

3. SNMP Trap Notification Configurations

Event Notification Table refers to Appendix E. Before the client side SNMP manager application accepts the RAID storage traps, it is necessary to integrate the MIB into the management application's database of events and status indicator codes. Ensure the compilation process successfully integrates the contents of the `areca_sas.mib` file into the traps database. Please refer to Appendix D of "SNMP Operation & Installation". The MIBs file resides at: `<CD-ROM>\packages\SNMP_MIBs` on the software CD.

ARCHTTP PROXY SERVER INSTALLATION

Note:

After you confirm and submit configurations, you can use "Generate Test Event" feature to make sure these settings are correct.

● **Rescan Device Configuration:**

The ArchHTTP scans the RAID controllers on the system and creates an individual RAID controller icon located on left column of the "ArchHTTP Configurations" screen. If any RAID controller is missed at system start-up, then you can use the "Rescan Device" function to rescan the targets to allow a missed RAID storage to be added.

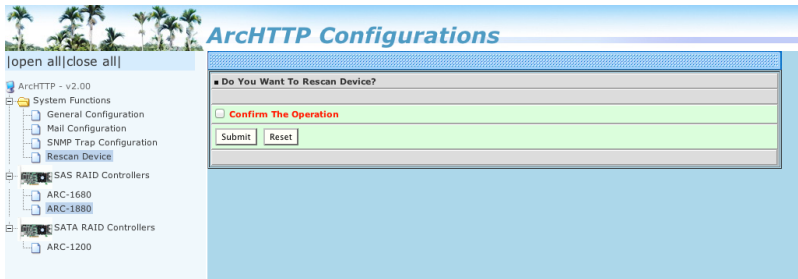

● **Collect Support Data:**

The "Collect Support Data" option on the ArchHTTP is used to download all controller's information (system information, configuration, disk information and event log) to a supported file (file name:ctrlxx-xxxxx.log). It will be automatically started when ERROR or SERIOUS event has occurred.

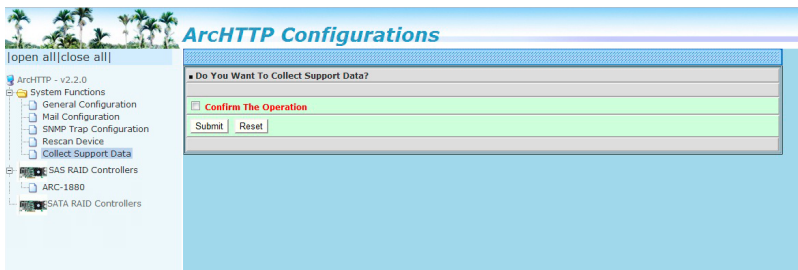

WEB BROWSER-BASED CONFIGURATION

6. Web Browser-based Configuration

Before using the firmware-based browser McRAID storage manager, do the initial setup and installation of this product. If you need to boot up the operating system from a RAID volume set, you must first create a RAID volume by using McBIOS RAID manager. Please refer to section 3.3 Using Quick Volume /Raid Setup Configuration for information on creating this initial volume set.

The McRAID storage manager is firmware-based utility, which is accessible via the web browser installed on your operating system. The web browser-based McRAID storage manager is a HTML-based application, which utilizes the browser (IE, Chrome and Mozilla etc.) installed on your monitor station.

It can be accessed through the in-band PCIe bus or out-of-band LAN port. ArchHTTP is used to launch the in-band web browser-based McRAID storage manager. The firmware-embedded web browser-based McRAID storage manager allows local or remote to access it from any standard internet browser via a LAN or WAN with no software or patches required. The firmware contains SMTP manager monitors all system events and user can select either single or multiple user notifications to be sent via LAN with "Plain English" e-mails. The firmware-embedded SNMP agent allows remote to monitor events via LAN with no SNMP agent required. Use the McRAID storage manager to:

- Create RAID set
- Expand RAID set
- Define volume set
- Add physical drive
- Modify volume set
- Modify RAID level/stripe size
- Define pass-through disk drives
- Modify system function
- Update firmware
- Designate drives as hot spares

6.1 Start-up McRAID Storage Manager

With McRAID storage manager, you can:

WEB BROWSER-BASED CONFIGURATION

- Locally manage a system containing a supported RAID storage that has Windows or Mac OS X, ArchHTTP and a supported browser.
- Remote and managed systems must have a TCP/IP connection.
- **Start-up from Windows/Mac Local Administration**

Once ArchHTTP and CLI have been installed, the ArchHTTP - background task automatically starts each time when you start your computer. There is one MARID icon showing on your "Desktop" or "Start" menu. This icon is for you to start up the ArchHTTP (launch the McRAID storage manager) and CLI utility. When you click on the ArchHTTP from MRAID icon, it shows all RAID controllers available on the host system and create an individual RAID controller icon located on left column of the "ArchHTTP Configurations" screen. This RAID controller icon is for user to launch the selected RAID controller web browser McRAID storage manager.

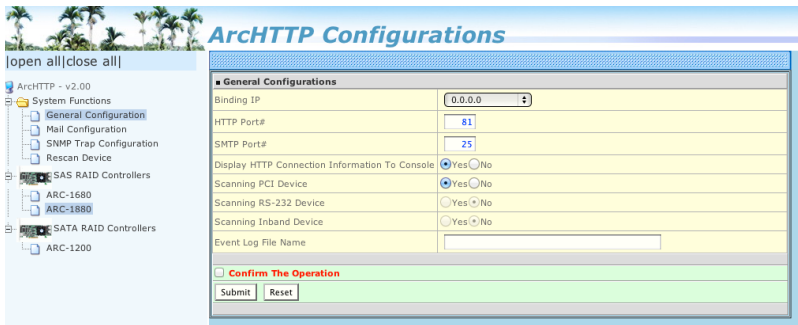

Locate "ARC-1883 Web Management" and launch the selected McRAID storage manager. Enter RAID storage default User Name "admin" and the Password "0000" when the login page prompted for it. After logging in, the McRAID storage manager process starts.

- **Start-up from Local Administration**

To configure the internal SAS RAID controller. You need to know its IP address. You can find the IP address assigned by the ArchHTTP proxy server installation: Binding IP:[X.X.X.X] and controller listen port.

WEB BROWSER-BASED CONFIGURATION

1. You can click on the individual adapter icon located on left column of the "ArcHTTP Configurations" screen or Launch your McRAID storage manager by entering `http://[Computer IP Address]:[Port Number]` in the web browser.
2. When connection is established, the "System Login" screen appears. The SAS RAID controller default user name is "admin" and the password is "0000".

● Start-up from Ethernet Port (Out-of-Band)

The SAS RAID controller also offers an alternative out-of-band method for McRAID storage manager. User can access the built-in configuration without running the ArcHttp proxy server on the host system. The web browser-based McRAID storage manager is a HTML-based application, which utilizes the browser installed on your remote system. To ensure proper communications between the SAS RAID controller and McRAID storage manager, please connect the SAS RAID controller LAN port to any LAN switch port.

The RAID storage has embedded the TCP/IP & web browser-based McRAID storage manager in the firmware. User can remote manage the SAS RAID controller without adding any user specific software (platform independent) via standard web browsers directly connected to the 10/100Mbit RJ45 LAN port.

To configure SAS RAID controller on a remote machine, you need to know its IP address. The IP address is default shown on the LCD initial start-up screen. Launch your McRAID storage manager by entering `http://[IP Address]` in the web browser.

Note:

You can find controller Ethernet port IP address in McBIOS RAID manager "System Information" option.

WEB BROWSER-BASED CONFIGURATION

6.2 McRAID Storage Manager

The following login screen is displayed in the browser. This screen displays the initial start-up configuration.

The screenshot displays the Areca Technology Corporation web browser-based configuration interface. The interface is divided into a navigation menu on the left and a main content area. The navigation menu includes options like "Raid System Controls", "Quick Function", "RAID Set Functions", "Volume Set Functions", "Physical Drives", "System Controls", "Information", "RAID Set Hierarchy", "SAS Chip Information", "System Information", and "Hardware Monitor". The main content area shows the "RAID Set Hierarchy" table, which lists RAID sets and their associated devices and volume sets. Below this, there are two tables for enclosure information: "Enclosure#1: ARECA SAS RAID AdapterV1.0" and "Enclosure#2: Areca ARC-8016-.B0.00.b000(27)[S001B4690801823F]".

RAID Set	Devices	Volume Set (Ch/Id/Lun)	Volume State
Raid Set # 000	E#3SLOT 11	ARC-1882-VOL#000(0/0/0)	Normal
	E#3SLOT 03	ARC-1882-VOL#002(0/0/3)	Normal
	E#2SLOT 03		
	E#2SLOT 04		
	E#2SLOT 06		
	E#2SLOT 07		
	E#2SLOT 10		
	E#3SLOT 01		
	E#3SLOT 02		
Raid Set # 001	E#3SLOT 12	ARC-1882-VOL#001(0/0/1)	Normal
	E#3SLOT 13	ARC-1882-VOL#002(0/0/2)	Normal
	E#2SLOT 02	ARC-1882-VOL#003(0/0/4)	Normal
	E#3SLOT 04	ARC-1002-VOL#004(0/0/5)	Normal
	E#2SLOT 01	ARC-1882-VOL#005(0/0/6)	Normal
	E#3SLOT 06		

Device	Usage	Capacity	Model
Slot#1	N.A.	N.A.	N.A.
Slot#2	N.A.	N.A.	N.A.
Slot#3	N.A.	N.A.	N.A.
Slot#4	N.A.	N.A.	N.A.
Slot#5	N.A.	N.A.	N.A.
Slot#6	N.A.	N.A.	N.A.
Slot#7	N.A.	N.A.	N.A.
Slot#8	N.A.	N.A.	N.A.

Device	Usage	Capacity	Model
SLOT_01[E]	Raid Set # 001 (1A)	300.1GB	HITACHI HUS156030VLS600
SLOT_02[D]	Raid Set # 001 (0A)	300.1GB	HITACHI HUS156030VLS600
SLOT_03[11]	Raid Set # 000 (0A)	300.1GB	HITACHI HUS156030VLS600

The RaidSet Hierarchy displays the "Raid Set List", "Volume Set List", and "Physical Disk List". The RAID set information, volume set information, and drive information can also be viewed by clicking on the "RAID Set Hierarchy" on the main menu screen.

- To display RAID set information, move the mouse cursor to the desired RAID set number, then click on it. The RAID set information will be displayed.
- To display volume set information, move the mouse cursor to the desired volume set number, then click on it. The volume set information will be displayed.
- To display drive information, move the mouse cursor to the desired physical drive number, then click on it. The drive information will be displayed.

WEB BROWSER-BASED CONFIGURATION

6.3 Main Menu

The main menu shows all available functions, accessible by clicking on the appropriate link.

Individual Category	Description
Quick Function	Create a default configuration, which is based on the number of physical disks installed; it can modify the volume set Capacity, Raid Level, and Stripe Size.
Raid Set Functions	Create a customized RAID set.
Volume Set Functions	Create customized volume sets and modify the existed volume sets parameter.
Physical Drives	Create pass through disks and modify the existing pass through drives parameters. Also provides the function to identify disk drives (blinking fault LED).
System Controls	Setting the RAID system configuration.
Information	Viewing the controller information. The Raid Set Hierarchy can be viewed through the "Raid Set Hierarchy" item.

6.4 Quick Function

The Quick Create option configures the arrays with just a few steps. Although drives of different sizes may be used in the array, Quick Create will only operate upon drives of the same physical size. The number of physical drives in the SAS RAID controller determines the Raid Levels that can be implemented with the RAID set. You can create a RAID set associated with exactly one volume set. The user can change the Raid Level, Capacity, Initialization Mode, and Stripe Size. A hot spare option is also created, depending on the exist configuration. Tick on the "Confirm The Operation" check box and click on the "Submit" button in the "Quick Create" screen, the RAID set and volume set will start to initialize.

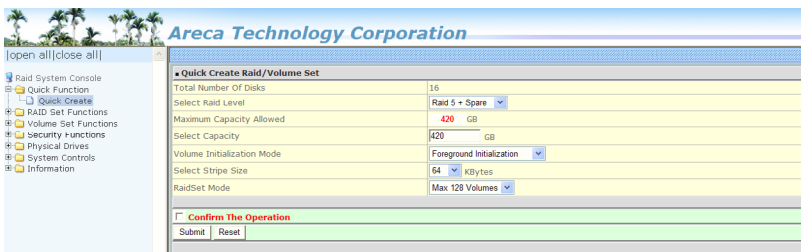

WEB BROWSER-BASED CONFIGURATION

Note:

In "Quick Create", your volume set is automatically configured based on the number of disks in your system. Use the "Raid Set Functions" and "Volume Set Functions" if you prefer to customize your volume set, or RAID 30/50/60 volume set.

6.5 Raid Set Functions

Use the "Raid Set Function" and "Volume Set Function" if you prefer to customize your volume set. Manual configuration can provide full control of the RAID set settings, but it will take longer to complete than the "Quick Volume/Raid Setup" configuration. Select the "Raid Set Function" to manually configure the RAID set for the first time or delete and reconfigure existing RAID sets. (A RAID set is a group of disks containing one or more volume sets.)

6.5.1 Create Raid Set

To create a RAID set, click on the "Create Raid Set" link. A "Select The Drive For RAID Set" screen is displayed showing the drive(s) connected to the current controller and enclosures. Click on the selected physical drives within the current RAID set. Enter 1 to 15 alphanumeric characters to define a unique identifier for a RAID set. The default RAID set name will always appear as "Raid Set #". Tick on the "Confirm The Operation" check box and click on the "Submit" button on the screen; the RAID set will start to initialize. If you have available disk member, you can repeat above procedures to define another RAID sets.

Areca Technology Corporation

[open all] [close all]

- Raid System Console
- Quick Function
- RAID Set Functions
 - Create RAID Set
 - Delete RAID Set
 - Expand RAID Set
 - Offline RAID Set
 - Rename RAID Set
 - Activate Incomplete RAID Set
 - Create Hot Spare
 - Delete Hot Spare
 - Rescue RAID Set
- Volume Set Functions
- Security Functions
- Physical Drives
- System Controls
- Information

Select The Drives For RAID Set

Enclosure#1 : SAS RAID Adapter V3.0

Slot#	Capacity	Drive Model
<input checked="" type="checkbox"/> Slot#1	6001.2GB	WDC WD6001FSYZ-01SS7B0
<input checked="" type="checkbox"/> Slot#2	6001.2GB	WDC WD6NPURX-64JCSY0
<input checked="" type="checkbox"/> Slot#3	4000.8GB	SEAGATE ST4000NM0023
<input checked="" type="checkbox"/> Slot#4	1000.2GB	SEAGATE ST31000424SS
<input checked="" type="checkbox"/> Slot#5	2000.4GB	TOSHIBA MK2001TRKB
<input checked="" type="checkbox"/> Slot#6	1000.2GB	ST1000DM003-9YN162
<input checked="" type="checkbox"/> Slot#7	2000.4GB	Hitachi HD5722020BLA642
<input checked="" type="checkbox"/> Slot#8	6001.2GB	WDC WD60EFRX-68L0BN1

Raid Set Name:

RaidSet Mode:

Confirm The Operation

Submit | Reset

WEB BROWSER-BASED CONFIGURATION

128 volumes is the default mode for SAS RAID controller, the 16 volumes mode is used for support roaming this raidset to SATA RAID controllers. The SATA RAID controller is designed to support up to 16 volumes only. You have to use "Max 16 volumes" on the raidset mode if you plan to roam this raidset between SAS RAID controller and SATA RAID controller.

Note:

To create RAID 30/50/60 volume, you need create multiple RAID sets first (up to 8 RAID sets) with the same disk numbers on each RAID set. The max no. disk drives per RAID set: 32 for RAID 0/1/10(1E)/3/50/60 and 128 for RAID 00/100/30/50/60.

6.5.2 Delete Raid Set

To delete a RAID set, click on the "Deleted Raid Set" link. A "Select The RAID Set To Delete" screen is displayed showing all exist RAID sets in the current controller. Click on the RAID set number which you want to delete in the select column on the delete screen. Then, tick on the "Confirm The Operation" check box and click on the "Submit" button in the screen to delete it. The volume sets included in the "Delete RAID Set". It will be deleted by this action. But for the Raid 30/50/60, you need to delete the volumes belonging to those RAID sets.

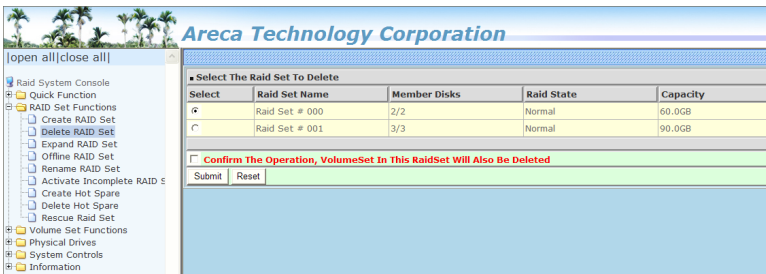

6.5.3 Expand Raid Set

Instead of deleting a RAID set and recreating it with additional disk drives, the "Expand Raid Set" function allows the users to add disk drives to the RAID set that have already been created. To expand a RAID set:

WEB BROWSER-BASED CONFIGURATION

Select the "Expand Raid Set" option. If there is an available disk, then the "Select SAS/SATA Drives For Raid Set Expansion" screen appears.

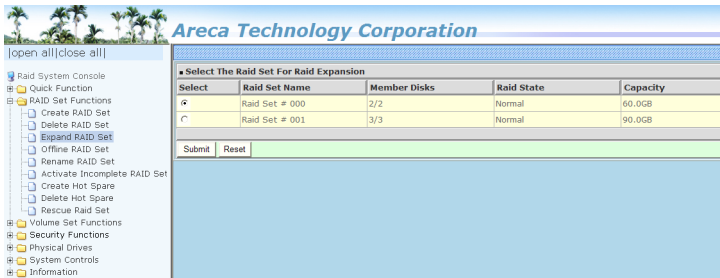

Select the target RAID set by clicking on the appropriate check box. Select the target disk by clicking on the appropriate check box. Click on the "Submit" button to start the expansion on the RAID set. The new additional capacity can be utilized by one or more volume sets. The volume sets associated with this RAID set appear for you to have chance to modify RAID level or stripe size. Follow the instruction presented in the "Modify Volume Set " to modify the volume sets; operation system specific utilities may be required to expand operating system partitions.

Note:

1. Once the "Expand Raid Set" process has started, user can not stop it. The process must be completed.
2. If a disk drive fails during RAID set expansion and a hot spare is available, an auto rebuild operation will occur after the RAID set expansion completes.
3. RAID 30/50/60 does not support the "Expand Raid set".
4. RAID set expansion is a quite critical process, we strongly recommend customer backup data before expand. Unexpected accident may cause serious data corruption.

6.5.4 Offline Raid Set

This function is for customer being able to unmount and remount a multi-disk volume. All Hdds of the selected RAID set will be put into offline state, spun down and fault LED in fast blinking mode. User can remove those Hdds and insert new Hdds on those empty slots without needing power down the controller to perform the online array roaming.

WEB BROWSER-BASED CONFIGURATION

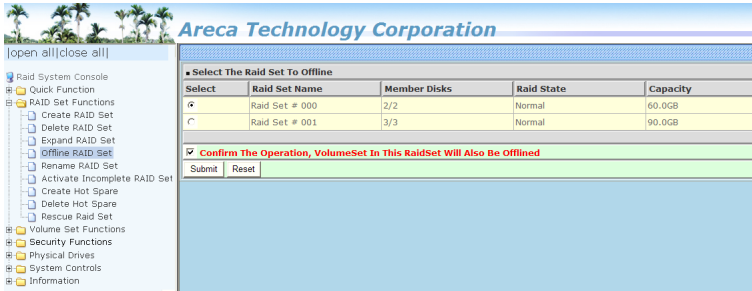

6.5.5 Rename Raid Set

The default RAID set name will always appear as "Raid Set #" when it is first created by the controller. The "Rename Raid Set" function is for customer to rename the default RAID set name.

To rename a RAID set from a group of RAID sets:

1. Click on the "Rename Raid Set" link.
2. Click on the RAID set check box from the list that you wish to rename. Click on the "Submit" button. The following screen appears. Use this option to rename the RAID set name.

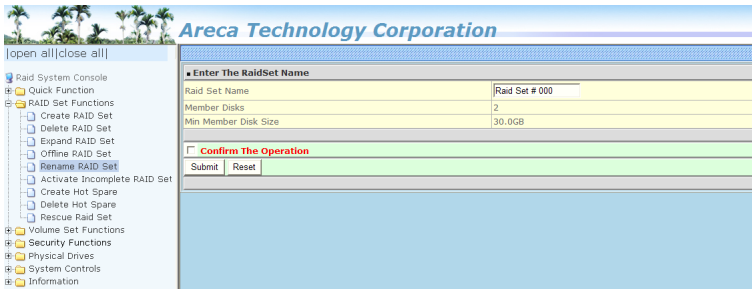

6.5.6 Activate Incomplete Raid Set

If one of the disk drives is removed in power off state, the RAID set state will change to "Incomplete State". If the user wants to continue to operate the controller without power-off the SAS RAID controller, the user can use the "Activate Incomplete Raid Set" option to active the RAID set. After the user completes this function, the Raid State will change to "Degraded Mode" and start to work. To activate the incomplete the RAID set, click on the "Activate Raid Set" link. A "Select The RAID SET To Activate" screen is displayed showing all RAID sets existing on the current controller.

WEB BROWSER-BASED CONFIGURATION

Click on the RAID set number to activate in the select column. Click on the "Submit" button on the screen to activate the RAID set that had a disk removed (or failed) in the power off state. The SAS RAID controller will continue to work in degraded mode.

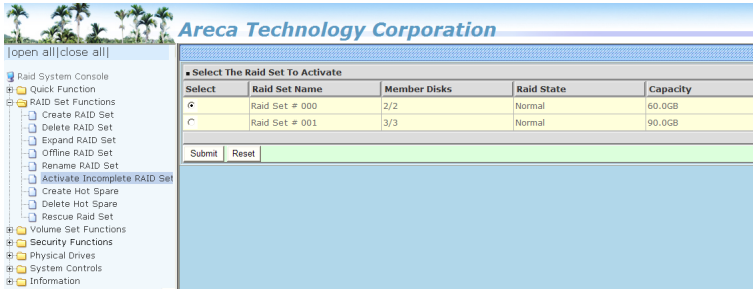

6.5.7 Create Hot Spare

When you choose the "Create Hot Spare" option in the "Raid Set Function", all unused physical devices connected to the current controller appear. Select the target disk by clicking on the appropriate check box. Tick on the "Confirm The Operation" check box and click on the "Submit" button in the screen to create the hot spares. The "Create Hot Spare" gives you the ability to define a global or dedicated hot spare. Unlike "Global Hot Spare" which can be used with any RAID sets, "Dedicated Hot Spare" can only be used with a specific RAID set or Enclosure. When a disk drive fails in the RAID set or enclosure with a dedicated hot spare is pre-set, data on the disk drive is rebuild automatically on the dedicated hot spare disk.

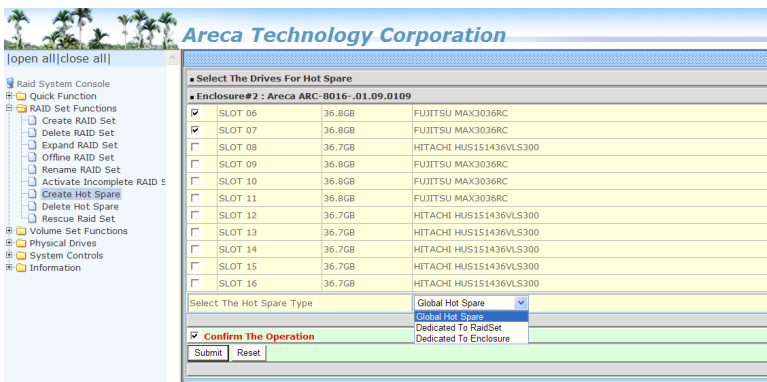

WEB BROWSER-BASED CONFIGURATION

6.5.8 Delete Hot Spare

Select the target hot spare disk to delete by clicking on the appropriate check box. Tick on the "Confirm The Operation" check box and click on the "Submit" button on the screen to delete the hot spares.

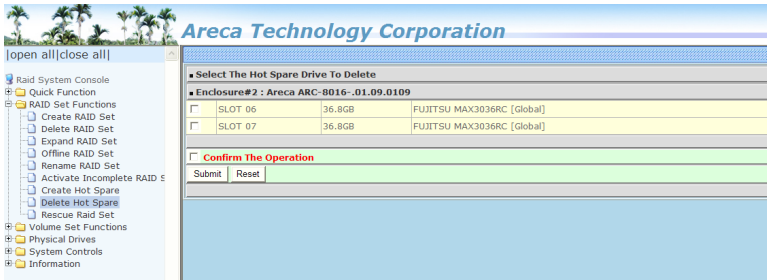

6.5.9 Rescue Raid Set

When the system is powered off in the RAID set update/creation period, the configuration possibly could disappear due to this abnormal condition. The "RESCUE" function can recover the missing RAID set information. The RAID controller uses the time as the RAID set signature. The RAID set may have different time after the RAID set is recovered. The "SIGANT" function can regenerate the signature for the RAID set.

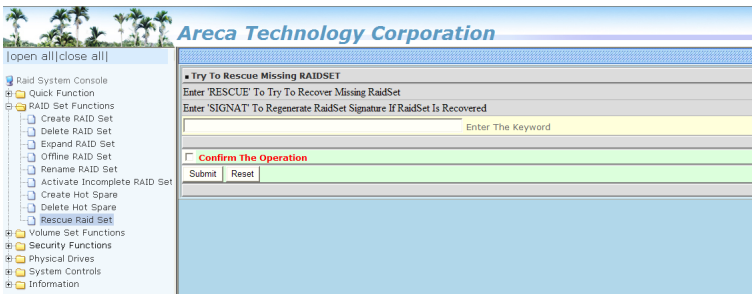

Note:

Please contact us to make sure if you need to use rescue function. Improperly usage may cause configuration corruption.

6.6 Volume Set Functions

A volume set is seen by the host system as a single logical device. It is organized in a RAID level with one or more physical disks. RAID level refers to the level of data performance and protection of a volume set. A volume set capacity can consume all or a portion of the disk capacity available in a RAID set. Multiple volume sets can exist on a group of disks in a RAID set. Additional volume sets created in a specified RAID set will reside on all the physical disks in the RAID set. Thus each volume set on the RAID set will have its data spread evenly across all the disks in the RAID set.

The following is the volume set features for the SAS RAID controller.

1. Volume sets of different RAID levels may coexist on the same RAID set and up to 128 volume sets per controller.
2. Up to 128 volume sets can be created in a RAID set.
3. The maximum addressable size of a single volume set is not limited to 2TB, because the controller is capable of 64-bit LBA mode. However the operating system itself may not be capable of addressing more than 2TB.

6.6.1 Create Volume Set (0/1/10/3/5/6)

To create volume set from RAID set system, move the cursor bar to the main menu and click on the "Create Volume Set" link. The "Select The Raid Set To Create On It" screen will show all RAID set number. Tick on a RAID set number that you want to create and then click on the "Submit" button.

The new create volume set attribute allows user to select the Volume Name, RAID Level, Capacity, Greater Two TB Volume Support, Initialization Mode, Strip Size, Cache Mode, Write Protect, Tagged Command Queuing, and SCSI Channel/SCSI ID/SCSI Lun.

WEB BROWSER-BASED CONFIGURATION

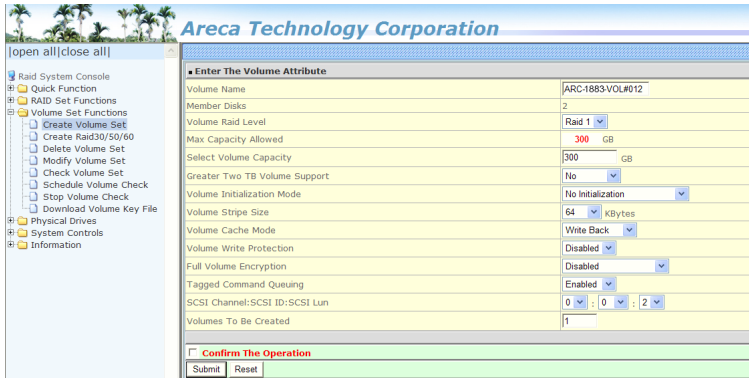

- **Volume Name**

The default volume name will always appear as "ARC-1883-VOL". You can rename the volume set providing it does not exceed the 15 characters limit.

- **Volume Raid Level**

Set the Raid Level for the volume set. Highlight the desired RAID Level from the available RAID levels option.

- **Capacity**

The maximum volume size is the default initial setting. Enter the appropriate volume size to fit your application.

- **Greater Two TB Volume Support**

Controller uses the "Greater Two TB Volume Support" sub-menu to set the volume capacity and sector size. Greater Two TB Volume Support option: "No", "64bit LBA" and "Use 4K Block".

- **No**

When this option is enabled, it keeps the volume size with max. 2TB limitation. For any hard disk drives working in the 4K native mode in the Raid set, the volume set directly sets and exposes 4KB sector size to the operating system.

- **64bit LBA**

This option uses 16 bytes CDB instead of 10 bytes. The maximum volume capacity up to 512TB. For any hard disk drives working in the 4K native mode in the Raid set, the

WEB BROWSER-BASED CONFIGURATION

volume set directly sets and exposes 4KB sector size to the operating system.

This option works on different OS which supports 16 bytes CDB.

- Use 4K Block

This option uses 16 bytes CDB and changes the sector size from default 512 bytes to 4k bytes. Windows XP only supports maximum volume capacity is up to 16TB.

● Initialization Mode

This option is used to define "Background Initialization", "Foreground Initialization" or "No Init (To Rescue Volume)". When "Background Initialization", the initialization proceeds as a background task, the volume set is fully accessible for system reads and writes. The operating system can instantly access to the newly created arrays without requiring a reboot and waiting the initialization complete. When "Foreground Initialization", the initialization proceeds must be completed before the volume set ready for system accesses. There is no initialization happened when you select "No Init" option. "No Init" is for customer to rescue volume without losing data in the disk.

Note:

- Controller starts to initialize the volume in two conditions
1. Stay in controller bios manager or
 2. Boot into OS and the controller driver loaded.

● Stripe Size

This parameter sets the size of the stripe written to each disk in a RAID 0, 1, 10, 5, 6, 50 or 60 logical drive. You can set the stripe size to 4 KB, 8 KB, 16 KB, 32 KB, 64 KB, 128 KB, 256KB, 512KB, or 1024KB. A larger stripe size produces better read performance, especially if your computer does mostly sequential reads. However, if you are sure that your computer does random reads more often, select a smaller stripe size.

WEB BROWSER-BASED CONFIGURATION

Note:

- RAID level 3 can't modify the cache stripe size.
- Roaming the stripe size 256K/512K/1024K Raid Set to firmware version older than 1.52 will cause data corruption.

● **Cache Mode**

The SAS RAID controller supports "Write Through" and "Write Back" cache.

● **Volume Write Protection**

When "Volume Write Protection" is enabled on the "Create Volume Set", host commands fail if they are issued to a volume in that RAID controller and attempt to modify a volume's data or attributes. Volume Write Protection is used primarily for customer-initiated disaster recovery testing.

● **Full Volume Encryption**

ARC-1883 RAID adapters have featured with controller based hardware encryption function. Controller based hardware encryption describes the encryption of data occurring at the disk array controller before being sent to the disk drives. Since RAID controller is a natural central point of all data therefore encryption at this level is inherent and also reduces deployment complexity. ARC-1883 RAID controller has dedicated electronic circuitry for the cryptographic engine embedded in the ROC and operating at full channel speeds. The hardware encryption does not impact the performance of ARC-1883 RAID controller and can implement on any kinds of HDD that is transparent to the user, the OS, and applications.

Encrypting your volume can give your data an extra layer of protection beyond setting up a controller password. Encryption will conceal your volume's data and make accessing the files almost impossible for anyone who does not know your encryption key. Data saved in the volume will be hidden by Algorithm developed by Areca Technology. With this scramble process, no one can see and access into the hidden volume data without access key. ARC-1883 adapters support 128- and 256-bit encryption keys using AES (a key size of 128, or 256

WEB BROWSER-BASED CONFIGURATION

bits), or password (a variable key size). Each encryption key size causes the algorithm to behave slightly differently, so the increasing key sizes not only offer a larger number of bits with which you can scramble the data, but also increase the complexity of the cipher algorithm. ARC-1883 adapters provide five new key options in the 'Full Volume Encryption:' 'Disable', '256Bit key, Password', '256Bit key, AES', '128Bit key, Password', '128Bit key, AES'. You can generate the new key by CLI utility or API code function.

This volume encryption function can only work with ARC-1883 series with any kinds of HDD. You can follow below steps to enable the function.

1. Create volume set with "Full Volume Encryption" capability in the web management.
2. Use CLI "vsf genkey" command or API code to generate key file.
3. Use "Download Volume Key File" in the web management or use CLI "vsf dlkey" command to download volume key file into firmware and unlock the volume.
4. Follow step 3. to unlock volume if volume locked.

Note:

The currently encryption feature only support key file interface to encrypt volumes.

● **Tagged Command Queuing**

The "Enabled" option is useful for enhancing overall system performance under multi-tasking operating systems. The Command Tag (Drive Channel) function controls the SAS command tag queuing support for each drive channel. This function should normally remain "Enabled". "Disabled" this function only when using SAS drives that do not support command tag queuing. Tagged Command Queuing (TCQ) is a technology built into SAS hard drives. It allows the RAID controller to send multiple read and write requests to a hard drive. This function should normally remain "Enabled". "Disabled" this function only when using SAS drives that do not support command tag queuing.

WEB BROWSER-BASED CONFIGURATION

- **SCSI Channel/SCSI ID/SCSI Lun**

SCSI Channel: The SAS RAID controller function is simulated as an external SCSI RAID controller. The host bus is represented as a SCSI channel. Choose the SCSI Channel.

SCSI ID: Each SCSI device attached to the SCSI card, as well as the card itself, must be assigned a unique SCSI ID number. A SCSI channel can connect up to 15 devices. The SAS RAID controller is a large SCSI device. Assign an ID from a list of SCSI IDs.

SCSI LUN: Each SCSI ID can support up to 8 LUNs. Most SAS controllers treat each LUN like a SAS disk.

6.6.2 Create Raid30/50/60 (Volume Set 30/50/60)

To create 30/50/60 volume set from RAID set group, move the cursor bar to the main menu and click on the "Create Raid30/50/60" link. The "Select The Raid Set To Create Volume On It" screen will show all RAID set number. Tick on the RAID set numbers (same disk No per RAID set) that you want to create and then click on the "Submit" button.

The new create volume set attribute allows user to select the Volume Name, Raid Level, Capacity, Greater Two TB Volume Support, Initialization Mode, Strip Size, Cache Mode, Write Protect, Full Volume Encryption, Tagged Command Queuing, and SCSI Channel/SCSI ID/SCSI Lun. Please refer to above section for details description of each item.

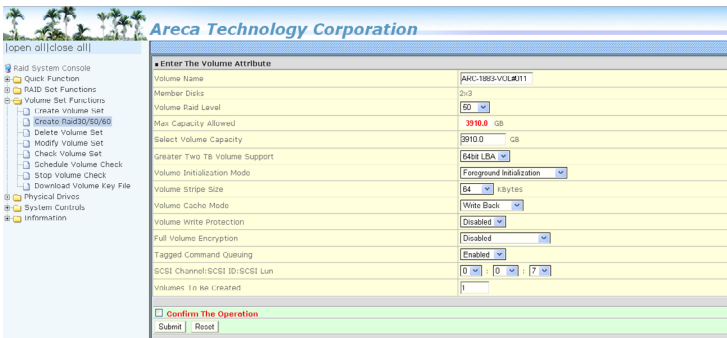

WEB BROWSER-BASED CONFIGURATION

Note:

RAID level 30 50 and 60 can support up to eight RAID set (four pairs), but it can not support expansion and migration.

6.6.3 Delete Volume Set

To delete a volume from RAID set, move the cursor bar to the main menu and click on the "Delete Volume Set" link. The "Select The Raid Set To Delete" screen will show all RAID set numbers. Click on a RAID set number and the "Confirm The Operation" check box and then click on the "Submit" button to show all volume set items in the selected RAID set. Click on a volume set number and the "Confirm The Operation" check box and then click on the "Submit" button to delete the volume set.

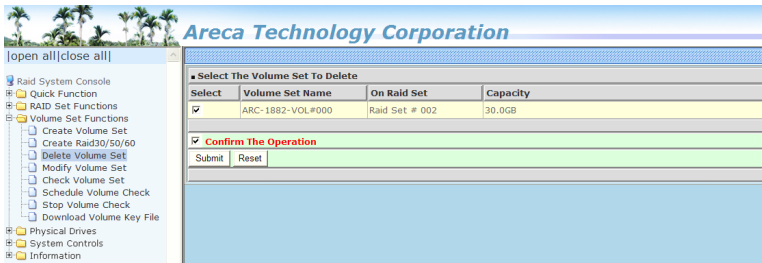

6.6.4 Modify Volume Set

To modify a volume set from a RAID set:

1. Click on the "Modify Volume Set" link.
2. Click on the volume set check box from the list that you wish to modify. Click on the "Submit" button. The following screen appears. Use this option to modify the volume set configuration. To modify volume set attributes, move the cursor bar to the volume set attribute menu on "Enter The Volume Attribute" screen and then click on the attribute to modify the value. After you complete the modification, tick on the "Confirm The Operation" check box and click on the "Submit" button to complete the action.

WEB BROWSER-BASED CONFIGURATION

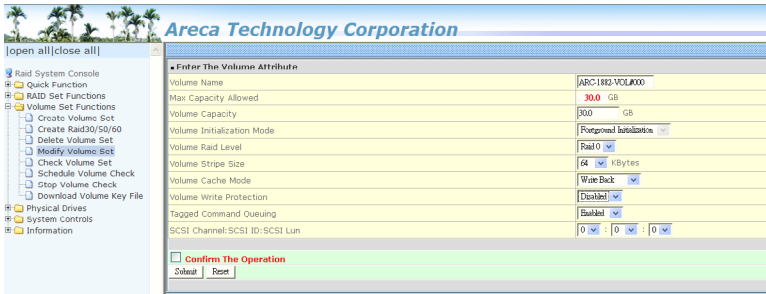

6.6.4.1 Volume Growth

Use "Expand RAID Set" function to add disk to a RAID set. The additional capacity can be used to enlarge the last volume set size or to create another volume set. The "Modify Volume Set" function can support the "Volume Modification" function. To expand the last volume set capacity, move the cursor bar to the "Capacity" item and entry the capacity size. When finished the above action, click on the "Submit" button to complete the action. The last volume set starts to expand its capacity. If you have free spaces from reserved or delete volumes, you can enlarge the last volume set size before the free spaces.

To expand an existing volume noticed:

- Only the last volume can expand capacity.
- When expand volume capacity, you can't modify stripe size or modify RAID level simultaneously.
- You can expand volume capacity, but can't reduce volume capacity size.
- After volume expansion, the volume capacity can't be decreased.

For greater 2TB expansion:

- If your system installed in the volume, don't expand the volume capacity greater 2TB, currently OS can't support boot up from a greater 2TB capacity device.
- Expand over 2TB used LBA64 mode. Please make sure your OS supports LBA64 before expand it.

WEB BROWSER-BASED CONFIGURATION

6.6.4.2 Volume Set Migration

Migrating occurs when a volume set is migrating from one RAID level to another, when a volume set strip size changes, or when a disk is added to a RAID set. Migration state is displayed in the volume state area of the "RAID Set Hierarchy" screen.

Areca Technology Corporation

RAID Set Hierarchy

RAID Set	Devices	Volume Set(Ch/M/Lun)	Volume State
Raid Set # 000	E#3SLOT_11	ARC-1882-VOL#000(0/0/0)	Normal
	E#3SLOT_03	ARC-1882-VOL#007(0/0/2)	Normal
	E#3SLOT_03		
	E#3SLOT_04		
	E#3SLOT_05		
	E#3SLOT_02		
	E#3SLOT_10		
	E#3SLOT_01		
	E#3SLOT_02		
Raid Set # 001	E#3SLOT_12	ARC-1882-VOL#001(0/0/1)	Normal
	E#3SLOT_11	ARC-1882-VOL#000(0/0/2)	Normal
	E#3SLOT_02	ARC-1882-VOL#003(0/0/4)	Normal
	E#3SLOT_04	ARC-1882-VOL#004(0/0/5)	Normal
	E#3SLOT_01	ARC-1882-VOL#005(0/0/6)	Normal
	E#3SLOT_06		

Enclosure#1: ARFCA SAS RAID AdapterV1.0

Device	Usage	Capacity	Model
Slot#1	N.A.	N.A.	N.A.
Slot#2	N.A.	N.A.	N.A.
Slot#3	N.A.	N.A.	N.A.
Slot#4	N.A.	N.A.	N.A.

Note:

1. If the volume is RAID level 30, 50, or 60, you can not change the volume to another RAID level. If the volume is RAID level 0, 1, 10(1E), 3, 5, or 6, you can not change the volume to RAID level 30, 50, or 60.
2. Power failure may damage the migration data. Please backup the RAID data before you start the migration function.

6.6.4.3 Volume Write Protection

When "Volume Write Protection" is enabled on the "Modify Volume Set", host commands fail if they are issued to a volume in that RAID controller and attempt to modify a volume's data or attributes. Volume Write Protection is used primarily for customer-initiated disaster recovery testing.

WEB BROWSER-BASED CONFIGURATION

6.6.5 Check Volume Set

To check a volume set from a RAID set:

1. Click on the "Check Volume Set" link.
2. Click on the volume set from the list that you wish to check.

Tick on "Confirm The Operation" and click on the "Submit" button. Use this option to verify the correctness of the redundant data in a volume set. For example, in a system with dedicated parity, volume set check means computing the parity of the data disk drives and comparing the results to the contents of the dedicated parity disk drive. The checking percentage can also be viewed by clicking on "RAID Set Hierarchy" in the main menu.

6.6.6 Schedule Volume Check

A volume check is a process that verifies the integrity of redundant data. To verify RAID 3, 5, 6, 30, 50 or 60 redundancy, a volume check reads all associated data blocks, computes parity, reads parity, and verifies that the computed parity matches the read parity.

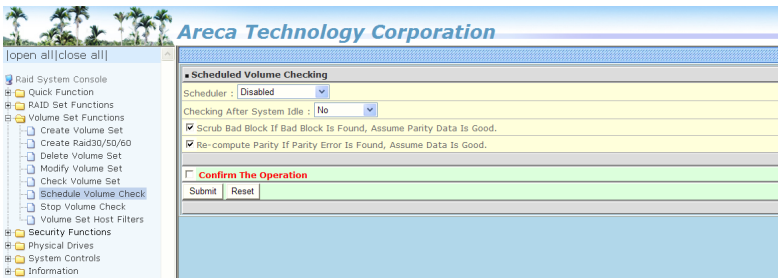

Volume checks are very important because they detect and correct parity errors or bad disk blocks in the drive. A consistency check forces every block on a volume to be read, and any bad blocks are marked; those blocks are not used again. This is critical and important because a bad disk block can prevent a disk rebuild from completing. We strongly recommend that you run consistency checks on a regular basis—at least once per week (set on 'Scheduler'). Volume checks degrade performance, so you can also run them when the system is idle (set by "Checking After System Idle").

WEB BROWSER-BASED CONFIGURATION

Note:

Please make sure of the inconsistency source generated by parity error or bad block before you click on the recovery method. Otherwise, you will lose the recovery data.

6.6.7 Stop Volume Set Check

Use this option to stop the "Check Volume Set" function.

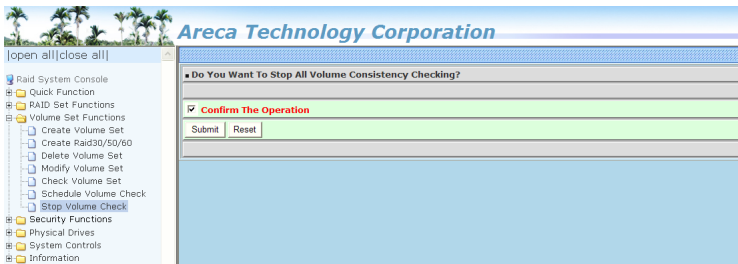

6.6.8 Download Volume Key File

Get the key file which was generated by CLI "vsf genkey" command or API code for your ARC-1883 adapters. You can follow below steps to download volume key file.

1. To download volume key file into the firmware, move the mouse cursor to "Download Volume Key file" link and click on it. The "Download Volume Encryption Key File" screen appears.
2. Click on "Browse". Look in the location to which the key file was generated. Select the file name and click "Open".
3. Tick "Confirm The Operation" and press the "Submit" button.
4. After the key file download is completed, a bar indicator will show "Key File Has Been Downloaded Successfully".

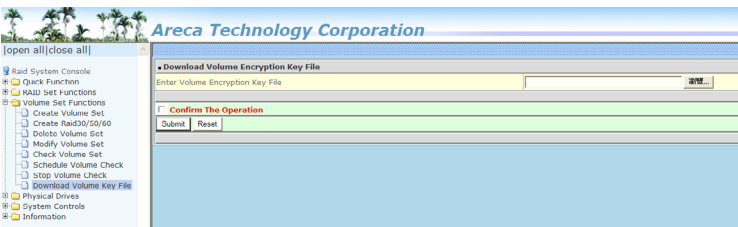

6.7 Security Function

The “Security Function” on the new firmware supports Self-Encrypting Disks (SED) for protection of data against loss or theft of SEDs. Protection is achieved by the use of encryption technology on the drives. The McRAID storage management allows SED keys to be created and managed as well as create/delete RAID sets. The following section provides the “Security Function” instructions to perform the custom configuration tasks. All SED functions are integrated into the intuitive and user friendly McRAID manager interface for easy access. Choose this option from the main menu and then perform the operations listed below.

6.7.1 Create SED RAID Set

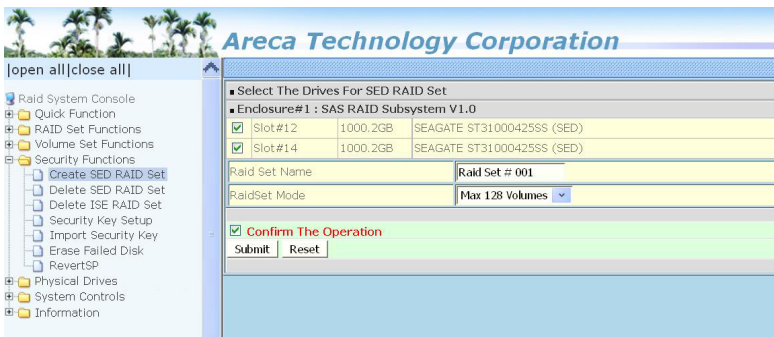

To create a SED RAID set, click on the “Create SED Raid Set” link. A “Select The Drive For SED RAID Set” screen is displayed showing the SED drive(s) connected to the current controller and enclosures. Click on the selected physical drives within the current RAID set. Enter 1 to 15 alphanumeric characters to define a unique identifier for a SED RAID set. The default RAID set name will always appear as “Raid Set #”. Tick on the “Confirm The Operation” check box and click on the “Submit” button on the screen; the RAID set will start to initialize. If you have available disk member, you can repeat above procedures to define another RAID sets. The Max 128 Volumes is the default mode for RAID controller.

WEB BROWSER-BASED CONFIGURATION

6.7.2 Delete SED RAID Set



A SED RAID Set is a RAID Set that has been locked on a controller that holds a security key. When you delete existing SED RAID sets, there has one option available to perform an Instant Secure Erase. The "Secure Erase The Member Disks" function is the process of permanently erasing all data on the SED disks and resetting the security attributes. The data on the SED disk is lost.

To delete a SED RAID set, click on the "Deleted Raid Set" link; a "Select The SED RAID Set To Delete" screen is displayed showing all exist SED RAID sets in the current controller. Click on the SED RAID set num-ber which you want to delete in the select column on the delete screen. Then, tick on the "Confirm The Operation" check box and click on the "Submit" button in the screen to delete it. The volume sets included in the "Delete SED RAID Set". It will be deleted by this action. But for the Raid 30/50/60, you need to delete the volumes belonging to those SED RAID sets.

6.7.3 Delete ISE RAID Set



WEB BROWSER-BASED CONFIGURATION

Instant Secure Erase (ISE) or Crypto Erase allows a drive to be instantly erased using industry-standard commands and options. An ISE RAID Set is a RAID Set that has been created by a group of ISE only SAS hard disks on a controller. When you delete existing SED RAID sets, there has one option available to perform an Instant Secure Erase. The "Secure Erase The Member Disks" function is the process of permanently erasing all data on the ISE disks and resetting the security attributes. The data on the ISE disk is lost.

To delete an ISE RAID set, click on the "Deleted ISE Raid Set" link. A "Select The ISE RAID Set To Delete" screen is displayed showing all exist ISE RAID sets in the current controller. Click on the RAID set num-ber which you want to delete in the select column on the delete screen. Then, tick on the "Confirm The Operation" check box and click on the "Submit" button in the screen to delete it. The volume sets included in the "Delete ISE RAID Set". It will be deleted by this action. But for the Raid 30/50/60, you need to delete the volumes belonging to those ISE RAID sets.

6.7.4 Security Key Setup

The Areca RAID controllers support Self-Encrypting Disks (SED) for protection of data against loss or theft of SEDs. Protection is achieved by the SED hard drive that automatically and continuously encrypts the data on the drive without any user interaction. There is one SED key per controller. You can manage the SED key under McRAID manager. Local SED key management in the controller firmware is designed to protect data from security breaches with minimal cost and complexity. The key can be escrowed in to a file using McRAID manager. Creating and managing SED key is an important part of the cryptographic process. The key must be kept secret from anyone who should not decrypt your data. This section describes how to generate and manage keys.

6.7.4.1 SED Key Management-Creation

There is one SED key per controller which stores in the controller flash memory. Areca provides both automatically or password methods to generate a key.

WEB BROWSER-BASED CONFIGURATION

1. SED Key is generated automatically by internal random number for a SED RAID set use without needing a password input.
2. SED Key is generated by user supplied password for a SED RAID set use.



6.7.4.2 SED Key Management-Modification

If you have evidence that the SED key is known to unauthorized users, you can change the SED key again. The 'Disable SED Key' function is used to clear SED key on controller and RAID set members.



In some cases, you may want to export a SED key to store on removable media or to use on a different computer. If you want to create a backup copy of the SED key or use it on another computer, you must first export the SED key. Exporting the SED key puts it in a file (filename.bin) that you can then transfer to another computer or put in a safe place.

WEB BROWSER-BASED CONFIGURATION



6.7.5 Import Security Key

SED RaidSet created on an Areca RAID adapters can be migrated to another RAID adapter. If you are importing a RaidSet originally secured with a SED key, you need to import the foreign SED key files to secure or unlock that RaidSet. The "Import Security Key" file is for Raidset Roaming or Change SED Key function. If you roam a RaidSet from old controller to another new (with Security Functions support), the foreign SED key file must be imported before it can be used.

1. Select the "RaidSet Roaming" option to unlock the locked disk and personalize to new controller's SED key. If there is an existing SED key on new controller, RaidSet is updated with the new security key. If there is not an existing SED key on new controller, RaidSet is updated to unlock RaidSet.
2. Select the "Change SED Key" option to unlock the locked disk and change to foreign SED key.



WEB BROWSER-BASED CONFIGURATION

6.7.6 Erase Failed Disk

To erase the failed encryption-capable physical disk, move the cursor bar to the main menu and click on the "Erase Failed Disk" link. The "Select The Device To Erase" screen will show all failed encryption-capable physical disks. Tick on the failed disk that you want to erase and then click on the "Submit" button. In case controller successfully performs an Instant Secure Erase, it will erase all data on the encryption-capable physical disk disks and reset the security attributes. The data on the encryption-capable physical disk is lost.

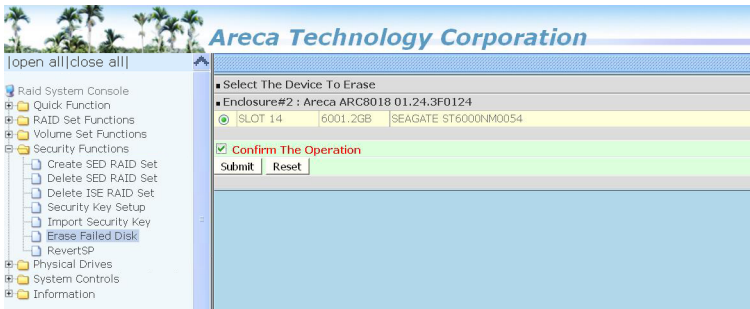

6.7.7 RevertSP

SED models will support the RevertSP feature which erases all data in all bands on the device and returns the contents of all SPs (Security Providers) on the device to their original factory state. In order to execute the RevertSP method the unique PSID (Physical Secure ID) printed on the drive label must be provided. PSID is not electronically accessible and can only be manually read from the drive label.

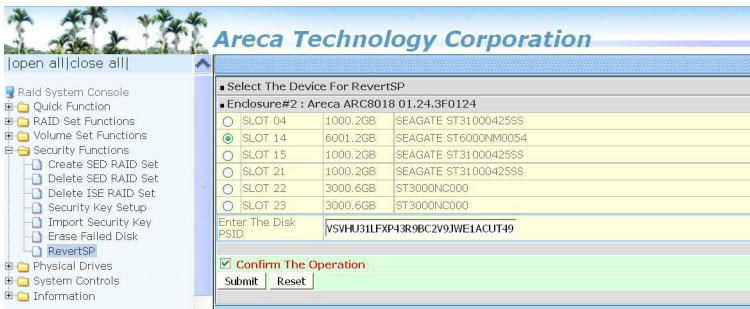

6.8 Physical Drive

Choose this option to select a physical disk from the main menu and then perform the operations listed below.

6.8.1 Create Pass-Through Disk

To create pass-through disk, move the mouse cursor to the main menu and click on the "Create Pass-Through" link. The relative setting function screen appears. You can select one, dual or three disks for pass-through disk function. A mirrored pass-through mode means controller will be regarded as the hard disk clone function, a host's data will write simultaneously into two or three hard disks in the RAID controller. If you combine an SSD and HDDs in a mirrored pass-through hybrid solution, you can get all the reads from the SSD with SSD speed. A pass-through disk is not controlled by the SAS RAID controller firmware, it can't be a part of a volume set. The disk is available to the operating system as an individual disk. It is typically used on a system where the operating system is on a disk not controlled by the RAID firmware. The user can also select the Volume Cache Mode, Write Protection, Tagged Command Queuing, and SCSI channel/SCSI_ID/SCSI_LUN for this pass-through disk.

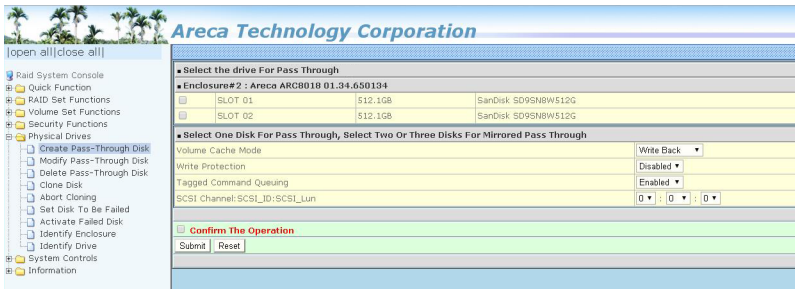

6.8.2 Modify Pass-Through Disk

Use this option to modify the pass-through disk attribute. The user can modify the Cache Mode, Write Protect, Tagged Command Queuing, and SCSI Channel/ID/LUN on an existing pass-through disk.

WEB BROWSER-BASED CONFIGURATION

To modify the pass-through drive attribute from the pass-through drive pool, move the mouse cursor bar and click on the “Modify Pass-Through” link. The “Select The Pass Through Disk For Modification” screen appears mark the check box for the pass-through disk from the pass-through drive pool and click on the “Submit” button to select drive. When the “Enter Pass-Through Disk Attribute” screen appears, modify the drive attribute values, as you want. After you complete the selection, mark the check box for “Confirm The Operation” and click on the “Submit” button to complete the selection action.

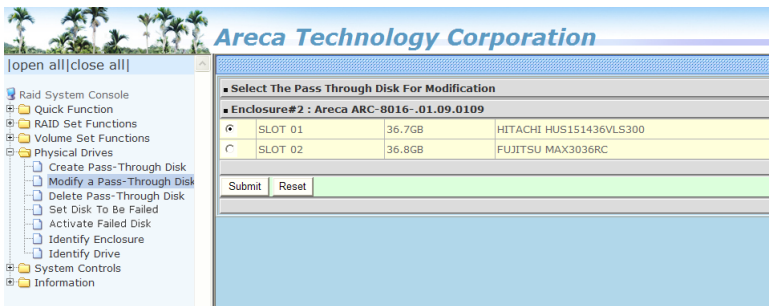

6.8.3 Delete Pass-Through Disk

To delete a pass-through drive from the pass-through drive pool, move the mouse cursor bar to the main menus and click on the “Delete Pass Through” link. After you complete the selection, mark the check box for “Confirm The Operation” and click on the “Submit” button to complete the delete action.

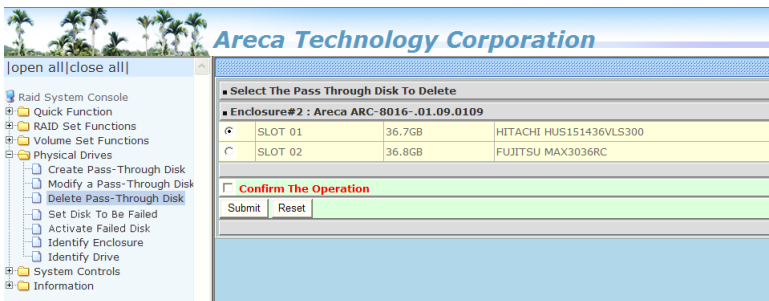

WEB BROWSER-BASED CONFIGURATION

6.8.4 Clone Disk

Instead of deleting a RAID set and recreating it with larger disk drives, the "Clone Disk" function allows the users to replace larger disk drives to the RAID set that have already been created. Click on the "Clone Disk" option on the "Physical Drives" link to enable the clone function. If there is an available disk, then the "Select The Drives For Cloning" screen appears. There are two "Clone Disk" function options: "Clone And Replace" and "Clone Only."

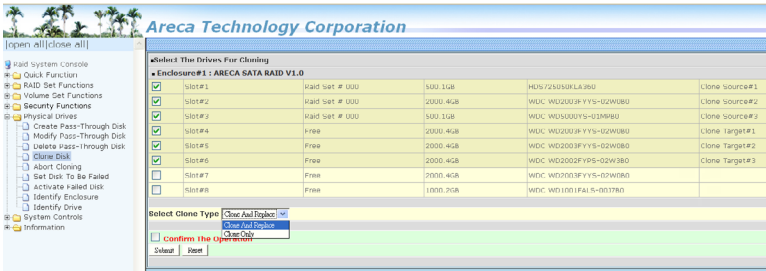

Clone Disk Procedure

1. Select one of the members as the "Clone Source" (status indicated as Raid Set #) by clicking on the appropriate check box.
2. Select a "Clone Target" (status indicated as Free or Hot Spare) by clicking on the appropriate check box.
3. If you have available disk member, you can repeat above procedures to define another clone pair.
4. Select clone type.

The pair number for both the "Clone Source" and the "Clone Target" will be indicated in the screen. Tick on the "Confirm The Operation" check box and click on the "Submit" button on the screen; the controller will automatically start the cloning process using the existing "stand-by" (Free or Hot Spare drive) to clone the source drive (the Raid Set member drive). The cloning process percentage will be indicated in the "Volume State" area of the "Volume Set Information" screen. Completion of the Clone function process will be indicated by a notification message on the event log.

WEB BROWSER-BASED CONFIGURATION

6.8.4.1 Clone And Replace

You can enlarge your logical drives by copying and replacing all member drives with drives of higher capacity. The existing data in the logical drives is copied onto the new drives, and then the original members are marked as "Offline".

6.8.4.2 Clone Only

The stand-by disk will clone the logical drives without substituting it. The status of the stand-by drive will be marked as "Offline" after the cloning process. The source drive will remain a member of the logical drive.

6.8.5 Abort Cloning

Use this function to stop the ongoing clone disk action.

6.8.6 Set Disk To Be Failed

It sets a normal working disk as "failed" so that users can test some of the features and functions.

Areca Technology Corporation

open all | close all |

- Raid System Console
 - Quick Function
 - RAID Set Functions
 - Volume Set Functions
 - Physical Drives
 - Create Pass-Through Disk
 - Modify Pass-Through Disk
 - Delete Pass-Through Disk
 - Set Disk To Be Failed**
 - Activate Failed Disk
 - Identify Enclosure
 - Identify Drive
 - System Controls
 - Information

■ Select The Device To Set To Fail

■ Enclosure#3 : Areca ARC-8016-B0.00.0000

SLOT	Capacity	Model
<input checked="" type="radio"/> SLOT 01	1000.2GB	WDC WD1001FALS-00J7B0
<input type="radio"/> SLOT 02	1000.2GB	WDC WD1002FAEX-00Z3A0
<input type="radio"/> SLOT 03	300.0GB	SEAGATE ST3300657SS
<input type="radio"/> SLOT 04	36.7GB	SEAGATE ST336754SS
<input type="radio"/> SLOT 05	300.1GB	WDC WD3000HLFS-01G6U0
<input type="radio"/> SLOT 06	1000.2GB	WDC WD1003FBYX-01Y7B0
<input type="radio"/> SLOT 07	500.1GB	WDC WD5000YS-01MPB0
<input type="radio"/> SLOT 08	1000.2GB	WDC WD1001FALS-00J7B0
<input type="radio"/> SLOT 09	600.1GB	WDC WD6000HLHX-01J3P0
<input type="radio"/> SLOT 10	600.1GB	WDC WD6000HLHX-01J3P0
<input type="radio"/> SLOT 11	500.1GB	WDC WD5000ABPS-01Z2B0
<input type="radio"/> SLOT 12	80.0GB	ST380013AS

Confirm The Operation

Submit Reset

WEB BROWSER-BASED CONFIGURATION

6.8.7 Activate Failed Disk

It forces the current “failed” disk in the system to be back online. “Activate Failed Disk” function has no effect on the removed disks, because a “removed” disk does not give the controller a chance to mark it as “failure”.

Followings are considered as “Removed-Disk”:

1. Manually removed by user.
2. Losing PHY connection due to bad connector, cable or back-plane.
3. Losing PHY connection due to disk fail.

Basically, in the eyes of the controller, the disk suddenly disappears due to whatever reason.

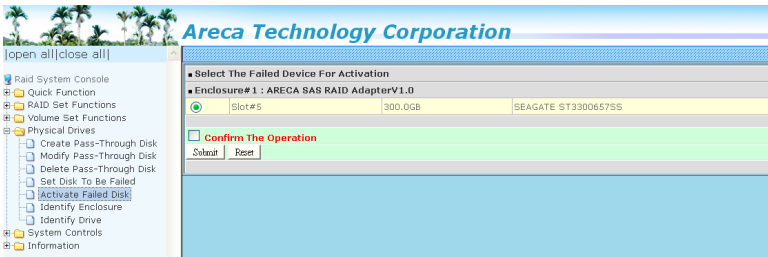

6.8.8 Identify Enclosure

To prevent removing the wrong enclosure, the selected Areca expander enclosure all disks fault LED indicator will light for physically locating the selected enclosure when the “Identify Enclosure” is selected. This function will also light up the enclosure LED indicator, if it is existed.

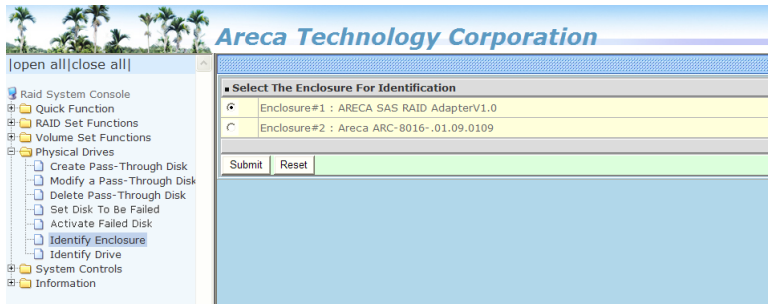

WEB BROWSER-BASED CONFIGURATION

6.8.9 Identify Drive

To prevent removing the wrong drive, the selected disk fault LED indicator will light for physically locating the selected disk when the "Identify Selected Device" is selected.

The screenshot shows the Areca Technology Corporation web browser-based configuration interface. The interface is divided into a navigation menu on the left and a main content area on the right. The navigation menu includes options such as 'Raid System Console', 'Quick Function', 'RAID Set Functions', 'Volume Set Functions', 'Physical Drives', 'System Controls', and 'Information'. The 'Physical Drives' option is expanded, showing sub-options like 'Create Pass-Through Disk', 'Modify a Pass-Through Disk', 'Delete Pass-Through Disk', 'Set Disk To Be Failed', 'Activate Failed Disk', 'Identify Enclosure', and 'Identify Drive'. The 'Identify Drive' option is selected. The main content area is titled 'Select The Device For Identification' and displays a table of 16 slots, each with a drive model and capacity. The table is as follows:

Enclosure#2 : Areca ARC-8016-.01.09.0109		
SLOT 01	36.7GB	HITACHI HUS151436VLS300
SLOT 02	36.8GB	FUJITSU MAX3036RC
SLOT 03	36.8GB	FUJITSU MAX3036RC
SLOT 04	36.8GB	FUJITSU MAX3036RC
SLOT 05	36.8GB	FUJITSU MAU3036RC
SLOT 06	36.8GB	FUJITSU MAX3036RC
SLOT 07	36.8GB	FUJITSU MAX3036RC
SLOT 08	36.7GB	HITACHI HUS151436VLS300
SLOT 09	36.8GB	FUJITSU MAX3036RC
SLOT 10	36.8GB	FUJITSU MAX3036RC
SLOT 11	36.8GB	FUJITSU MAX3036RC
SLOT 12	36.7GB	HITACHI HUS151436VLS300
SLOT 13	36.7GB	HITACHI HUS151436VLS300
SLOT 14	36.7GB	HITACHI HUS151436VLS300
SLOT 15	36.7GB	HITACHI HUS151436VLS300
SLOT 16	36.7GB	HITACHI HUS151436VLS300

At the bottom of the table, there are two buttons: 'Submit' and 'Reset'.

WEB BROWSER-BASED CONFIGURATION

6.9 System Controls

6.9.1 System Config

To set the RAID system function, move the cursor to the main menu and click on the "System Controls" link. The "Raid System Function" menu will show all items, and then select the desired function.

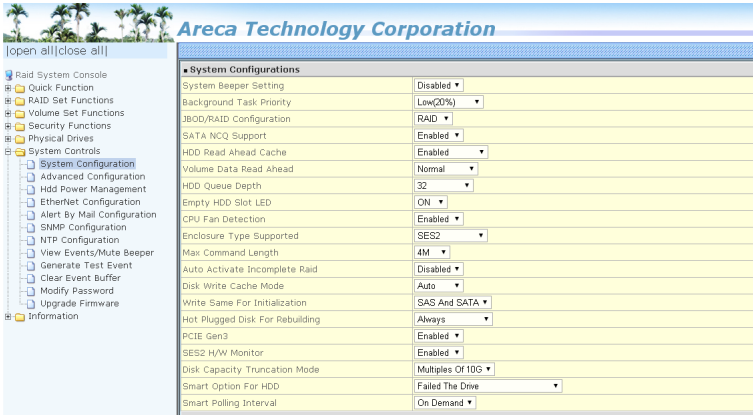

- **System Beeper Setting**

The "System Beeper Setting" function is used to "Disabled" or "Enabled" the SAS RAID controller alarm tone generator.

- **Background Task Priority**

The "Background Task Priority" is a relative indication of how much time the controller devotes to a rebuild operation. The SAS RAID controller allows the user to choose the rebuild priority (UltraLow, Low, Medium and High) to balance volume set access and rebuild tasks appropriately. For high array performance, specify a "Low" value.

- **JBOD/RAID Configuration**

JBOD is an acronym for "Just a Bunch Of Disk". A group of hard disks in a RAID box are not set up as any type of RAID configuration. All drives are available to the operating system as an individual disk. JBOD does not provide data redundancy. User needs to delete the RAID set, when you want to change the option from the RAID to the JBOD function.

WEB BROWSER-BASED CONFIGURATION

- **SATA NCQ Support**

The controller supports both SAS and SATA disk drives. The SATA NCQ allows multiple commands to be outstanding within a drive at the same time. Drives that support NCQ have an internal queue where outstanding commands can be dynamically rescheduled or re-ordered, along with the necessary tracking mechanisms for outstanding and completed portions of the workload. The SAS RAID controller allows the user to select the SATA NCQ support: "Enabled" or "Disabled".

- **HDD Read Ahead Cache**

Allow Read Ahead (Default: Enabled)—When Enabled, the drive's read ahead cache algorithm is used, providing maximum performance under most circumstances.

- **Volume Data Read Ahead**

The volume read data ahead parameter specifies the controller firmware algorithms which process the Read Ahead data blocks from the disk. The read ahead parameter is normal by default. To modify the value, you must set it from the command line using the Read Ahead option. The normal option satisfies the performance requirements for a typical volume. The disabled value implies no read ahead. The most efficient value for the controllers depends on your application. Aggressive read ahead is optimal for sequential access but it degrades random access.

- **HDD Queue Depth**

This parameter is adjusted the queue depth capacity of NCQ (SATA HDD) or Tagged Command Queuing (SAS HDD) which transmits multiple commands to a single target without waiting for the initial command to complete.

- **Empty HDD Slot LED**

The firmware has added the "Empty HDD Slot LED" option to setup the fault LED light "ON" or "OFF" when there is no HDD installed. When each slot has a power LED for the HDD installed identify, user can set this option to "OFF". Choose option "ON", the SAS RAID controller will light the fault LED; if no HDD installed.

WEB BROWSER-BASED CONFIGURATION

- **CPU Fan Detection**

The ARC-1883ix series incorporate one big passive heatsink attaching a active cooling fan that allows the hot devices such as a ROC and expander chip to keep cool. In addition, newer systems already have enough air flow blowing over the controller. If the systems have provided enough adequate cooling for ROC and expander chip, user can remove the attaching fan on the big passive heat sink.

The "CPU Fan Detection" function is available in the firmware for detecting the cooling fan function on the ROC if you want to use the active cooling fan on the ARC-1883i/x/LP low profile board. When using the passive heatsink only on the controller, disable the "CPU Fan Detection" function through this from McBIOS RAID manager setting or Web Browser.

- **SES2 Support**

If your SAS backplane does not implement the correct SES2 function, you can disable the SES2 support on controller. Controller will use SMP (only monitor PHY not environment) to communicate with SAS backplane, but you will be not able to monitor the backplane information.

- **Max Command Length**

Max Command Length is used to set a "best" IO size for the RAID controller.

- **Auto Activate Incomplete Raid**

When some of the disk drives are removed in power off state or boot up stage, the RAID set state will change to "Incomplete State". But if a user wants to automatically continue to work while the SAS RAID controller is powered on, the user can set the "Auto Activate Incomplete Raid" option to enable. The RAID state will change to "Degraded Mode" while it powers on.

- **Disk Write Cache Mode**

User can set the "Disk Write Cache Mode" to Auto, Enabled, or Disabled. "Enabled" increases speed, "Disabled" increases reliability.

WEB BROWSER-BASED CONFIGURATION

- **Write Same For Initialization**

Drives that support the Write Same feature (SCT) can write to multiple drive sectors at once, improving initialization time. To take advantage of this feature, all the drives in the unit must support Write Same. User can set the "SAS And SATA", "SAS Only", "SATA Only" or "Disabled" for the controller initialization.

- **Hot Plugged Disk For Rebuilding**

It defines if the RAID array volume should start rebuilding or not when detects a disk is inserted/re-inserted during online. The options are: "Blank Disk Only", "Always", and "Disable". The default is "Blank Disk Only".

"Blank Disk Only" – it will trigger the rebuilding if and only if the inserted disk has not been in the RAID array before, which has no RAID signature on it. So when a previously removed disk is self re-inserted, it won't trigger the degraded RAID array to rebuild, and so that the administrator has a chance to identify this mis-behaving disk and replaces it.

"Always" – it is what it was before. Whenever a disk is inserted/re-inserted whether new or previously existed, it always trigger a rebuilding for the Degraded RAID set/Volume.

"Disable" – it will not trigger rebuilding regardless what sort of disk plugging in.

When "Disable" and/or "Blank Disk Only" is selected, the re-inserted/previously removed disk will be identified as a disk in a separate RAID set with duplicated RAID set# and with all the rest of RAID members missing.

- **PCIE Gen3**

The "Disabled" option is used to force PCIe running Gen2 mode for compatible issue under Gen3 slot. You must restart the computer twice for the PCIe Gen3 setting to take effect.

- **Disk Capacity Truncation Mode**

Areca RAID controllers use drive truncation so that drives from differing vendors are more likely to be able to be used

WEB BROWSER-BASED CONFIGURATION

as spares for each other. Drive truncation slightly decreases the usable capacity of a drive that is used in redundant units. The controller provides three truncation modes in the system configuration: "**Multiples Of 10G**", "**Multiples Of 1G**", and "**Disabled**".

Multiples Of 10G: If you have 120 GB drives from different vendors; chances are that the capacity varies slightly. For example, one drive might be 123.5 GB, and the other 120 GB. Multiples Of 10G truncates the number under tens. This makes same capacity for both of these drives so that one could replace the other.

Multiples Of 1G: If you have 123 GB drives from different vendors; chances are that the capacity varies slightly. For example, one drive might be 123.5 GB, and the other 123.4 GB. Multiples Of 1G truncates the fractional part. This makes capacity for both of these drives so that one could replace the other.

Disabled: It does not truncate the capacity.

- **Smart Option For HDD**

This option is used to increase the reliability of SSDs/HDDs by automatically copying data from a drive with potential to fail to a designated hot spare or newly inserted drive. The options are: "Failed The Drive", "Failed The Drive If Hot Spare Exist", and "Alert Only". The default is "Alert Only".

"Failed The Drive"- controllers kill off the SMART fail drive immediately.

"Failed The Drive If Hot Spare Exist" – controllers kill off the SMART fail disk if hot spare drive is existed.

"Alert Only" – it will trigger alert when there happens a SMART failed drive.

- **Smart Polling Interval**

Besides the scheduled volume check, user can define the Smart Pulling Interval to pull the SMART status of each disk.

WEB BROWSER-BASED CONFIGURATION

The default is “on demand”. User can schedule every certain period of time interval to pull the SMART status of each disk. When SMART pulling is executed, disk activity will be temporarily halted until the SMART parameter reading is finished. That is why you don’t want to set the Interval too frequent. What to use is up to the users to decide based on their applications and experiment results.

6.9.2 Advanced Configuration

To set the RAID system function, move the cursor to the main menu and click on the “Advanced Configuration” link. The “Advanced Configuration” menu will show all items, then select the desired function.

The screenshot shows the 'Advanced Configurations' section of the RAID controller's web interface. The left sidebar contains a navigation tree with 'Advanced Configuration' selected. The main content area lists various settings:

Item	Value
TLER Setting	Default
Timeout Setting	8 Seconds
Number Of Retries	2
Buffer Threshold Setting	25%
Amount Of Read Ahead	Auto
Number Of AV Streams	6
Optimize AV Recording	Disabled
Read Performance Margin	No
Write Performance Margin	No
Read And Discard Parity Data	Disabled
Fail Disk For Any Timeout	Disabled
Hitachi SATA HDD Speed	Default
WDC SATA HDD Speed	Default
Seagate SATA HDD Speed	Default
BIOS Selection	Auto
PCIe Link Down Reset	Disabled
Active Cable Management	Auto
Host Command Queue Mode	Normal
End Device Frame Buffering	Enabled
PCIe Command Queue Depth	256
Write Cache Amount	Unfilled
Dual Path Usage	Load Balance By Slot
Save SEDKey In Controller	Enabled
Int Connector#1 Speed Limit	No Limit
Int Connector#2 Speed Limit	No Limit

● TLER Setting

TLER (time-limited error recovery) functions provide support for WD Caviar RE (RAID) series disks. This is a new option from WD to support RAID features that were traditionally missing from standard desktop drives. TLER is a method of signaling the system RAID controller in the event that an error recovery process is taking longer than time-out specifications allow. This prevents the RAID controller from dropping the drive from the array during this period. Default value is manufacture setting. You can select between 5, 6 and 7 second. This feature is to setup the HDD internal timeout value.

WEB BROWSER-BASED CONFIGURATION

- **Timeout Setting**

Disk time-out is a registry setting that defines the time that RAID controller will wait for a hard disk to respond to a command. You can modify the retry value by entering a new value in the edit box beside this button and then selecting the button. Normally you should not need to modify this value. Default value is 8 seconds: You can select between 3~8 second.

- **Number of Retries**

This setting determines the number of access that will be attempted before the current command from the RAID controller to the disk drive is aborted. You can modify the retry value by entering a new value in the edit box beside this button and then selecting the button. Normally you should not need to modify this value. There are two selections, either 2 retry or 3 retry.

- **Buffer Threshold**

This new feature there are 3 options; 25%, 50%, 75%. The percentage represents how much data should be kept in resident cache memory (how full cache should get) before controller starts to flush data onto the hard drives. If the buffer is set for 25%, then all 25% will be cached and is used for writing data. The remaining cache memory will be used for reading incoming write and other system overhead. Write buffer threshold for 5% is added for video recording. This option will push data to disk early.

This feature gives controller extra buffer time in case of slow response from the hard drives within a given time. Consequently, this can prevent a pause in data flow and there will be continues data access and stream. This feature is very useful for the video streaming applications where there is high demand for constant non-stop data flow with no interruption due to lower performance of specific hardware.

- **Amount of Read Ahead**

Read-Ahead data is buffered in the RAID controller cache, however, thereby cutting down on the amount of I/O traffic to the disk. The Amount of Read Ahead defines how many data of reading at a time, making more efficient use of the RAID sub

WEB BROWSER-BASED CONFIGURATION

system. This makes it possible to locate and re-issue the data without repetitive hard parsing activities. The Amount of Read Ahead parameter is used to allocate an amount of memory in the cache memory the frequently executed queries and return the result set back to the host without real disk read execution. Default value is Auto: Controller will base on the HDD number to set the amount of Read Ahead value. You can select between 512KB ~ 16MB.

● **Number of AV Stream**

RAID controllers are required to have not only the function of processing ordinary data but also the function of dealing with AV (audio/video) stream data needing real-time processing. Since the bus cycle used in RAID controller was designed to transfer the computer data exactly, it was unsuitable for the transfer of AV stream needing great band widths. They are required to do some setting for the handshaking during the processing of stream data. This setting is an object of transferring stream data efficiently on an existing RAID controller. Normally you should not need to modify this value. Default value is 6. You can select between 6~256.

To decide how to set AV stream playout parameter, you need to check the Number of Stream, Amount of Read Ahead, and Total Cache Memory during runtime. You can try to adjust the three numbers to get the best performance as your requirement. Number of Stream shows the number of stream added to the system, Amount of Read Ahead shows the amount of Read Ahead data taken from the cache without real disk execution, and total cache memory shows the total available memory being installed in the RAID controller.

● **Optimize AV Recording**

AV recording option is for video recording (no time limit), but if used in normal operation, performance may be degraded. This new feature there are 4 options; Disabled, Mode1, Mode2 and Mode 3. Default value is Disabled. Our controller cache uses LRU method, there have no special memory capacity reserved for read or write. The Mode 1, 2 and 3 are used to define the command sorting method. The default sorting method is helpful for normal applications, but not useful for AV applications, so we have defined three different sorting meth-

WEB BROWSER-BASED CONFIGURATION

ods for these special applications. To decide how to optimize AV stream recording parameter, you need to adjust the Optimize AV Recording, and Write Buffer Threshold during runtime.

- **Read Performance Margin**

The "Read Performance Margin" is for controller to reserve n% read margin during AV stream recording.

- **Write Performance Margin**

The "Write Performance Margin" is for controller to reserve n% write margin AV stream recording.

AJA Mode Usage:

1. Controller needs to reboot when you adjust the following settings.
 - (1). Optimize For AV Recording: change any setting
 - (2). Read Performance Margin : No <-> X%
 - (3). Write Performance Margin : No <-> X%
2. The following setting is changed for AJA mode, and reboot is required for the setting to take effect.

Setting and Usage			
Optimize AV	Read Margin	Write margin	Description
Mode 3	Any	Any	R/W AJA mode with throttling, no sorting
Mode Disabled/1/2	X%	X%	R/W AJA mode with throttling and sorting
Mode Disabled/1/2	X%	No	Read AJA mode with throttling and sorting
Mode Disabled/1/2	No	X%	Write AJA mode with throttling and sorting

<a>. Under Optimize For AV Recording mode: 3
Read Performance Margin and Write Performance Margin are enabled with "No" setting is 0%, reboot is not required to change Read Performance Margin and Write Performance Margin

. If Read Performance Margin or Write Performance Margin are changed to X%, reboot is not required to change X% to Y%.

WEB BROWSER-BASED CONFIGURATION

<c>. For NON-VIDEO application, the following setting is recommended

Buffer Threshold Setting: 25%

Optimize AV Recording: disabled

Example:

(1). Only write throttling is required

(a). Buffer Threshold Setting: 5%

(b). Optimize For AV Recording Mode left unchanged (Disabled)

(c). Read Performance Margin left unchanged (No)

(d). Write Performance Margin set to X%

(e). Reboot

(f). Adjust Write Performance Margin to fine tune the result (no reboot required)

(2). Read/Write Throttling is required and sorting is to be disabled

(1). Buffer Threshold Setting: 5%

(2). Optimize For AV Recording Mode set to 3

(3). Reboot

(4). Adjust Read/Write Performance Margin to fine tune the result (no reboot required)

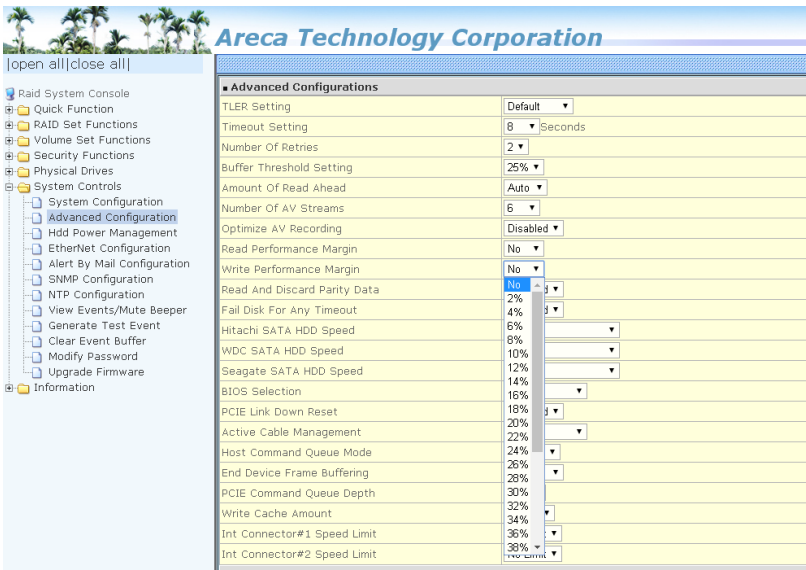

Areca Technology Corporation

open all | close all

- Raid System Console
- Quick Function
- RAID Set Functions
- Volume Set Functions
- Security Functions
- Physical Drives
- System Controls
 - System Configuration
 - Advanced Configuration
 - Hdd Power Management
 - EtherNet Configuration
 - Alert By Mail Configuration
 - SNMP Configuration
 - NTP Configuration
 - View Events/Mute Beeper
 - Generate Test Event
 - Clear Event Buffer
 - Modify Password
 - Upgrade Firmware
- Information

Advanced Configurations	
TLER Setting	Default
Timeout Setting	8 Seconds
Number Of Retries	2
Buffer Threshold Setting	25%
Amount Of Read Ahead	Auto
Number Of AV Streams	6
Optimize AV Recording	Disabled
Read Performance Margin	No
Write Performance Margin	No
Read And Discard Parity Data	No
Fail Disk For Any Timeout	2%
Hitachi SATA HDD Speed	4%
WDC SATA HDD Speed	6%
Seagate SATA HDD Speed	8%
BIOS Selection	10%
PCIE Link Down Reset	12%
Active Cable Management	14%
Host Command Queue Mode	16%
End Device Frame Buffering	18%
PCIE Command Queue Depth	20%
Write Cache Amount	22%
Int Connector#1 Speed Limit	24%
Int Connector#2 Speed Limit	26%

WEB BROWSER-BASED CONFIGURATION

- **Read And Discard Parity Data**

This function is used to determine if parity data is to be read and discarded.

- **Fail Disk For Any Timeout**

Imaging system products expect to have constant speed for writing raw data to the storage by constant speed without any data loss whenever a drive becomes failure in RAID system. This function is the option that RAID controller will kill off the HDD for any time out. It can reduce the write cache size to buffer the raw data.

- **Hitachi/WDC/Seagate SATA HDD Speed**

The purpose of this setting is to provide alternative method to change the interface speed of a SATA HDD speed so that it can be successfully utilized in some compatible condition. Reboot is required for this setting to take effect.

- **BIOS Selection**

It combines the "Legacy BIOS", "UEFI BIOS" and "EFI BIOS" into a single BIOS, and provides BIOS option in the GUI. In the old days, Areca provided separate BIOS files for each, and need to manually flash it in. Now flashing BIOS for different BIOS type is no longer needed, just make the BIOS selection in System Controls: Advance Configuration: BIOS Option.

The controller provides three BIOS options.

Legacy: for PC motherboards that are using regular BIOS boot.

UEFI: for PC motherboards using UEFI boot.

EFI: for Intel-based Mac boot

Disable: disable controller BIOS at POST (set to 0xFF)

==> If BIOS is to be disabled --> All data are 0xFF

- **PCIe Link Down Reset**

If SAS RAID adapters is experiencing problems with link down issue in some host M/B , please try to set the "PCIe Link Down Reset".

Enable: The RAID-on-Chip (ROC) PCIe link will be down and need to be re-initialized to get the link up.

Disable: The RAID-on-Chip (ROC) PCIe link will ignore the "PCIe link Down Reset" command.

WEB BROWSER-BASED CONFIGURATION

- **Active Cable Management**

An active cable requires power for circuitry that is integral to any of the TX/RX high speed serial channels supported by the cable. In addition, the active cable requires power to operate the management interface. There is one E2prom on the AOC cable that records the AOC capability 6 or 12 Gb/s, optical or no optical. This setting is for user to disable the E2prom value that it writes the wrong value. If select "Auto", it only works with the 8644 cable that has been programmed.

- **Host Command Queue Mode**

This option is used to solve the the problem with reads stalling that causes by out of order command completion. Choose the "Host Command Queue Mode" option="Ordered" on the "Advanced Configuration" if you want similar read/write throughputs. There the read and write get the same priority as they are scheduled and the reads are not pushed back.

- **End Device Frame Buffering**

Using the 12Gb/s SAS technology, including End Device Frame Buffering (EDFB) technology, the ROC and expander are designed to help ease the industry's transition to 12Gb/s SAS-enabled systems by enabling customers to take advantage of 12Gb/s speeds while using existing 6Gb/s drives and backplane infrastructure. This technology allows the expander to perform aggregation, essentially allowing two devices to share one port on the expander.

- **Write Cache Amount**

The "Write Cache Amount" is for controller to configure how much cache SDRAM dedicated for read, and how much for write. By default (Unified), the size of read or write cache is automatically assigned by the controller firmware. If your server application has significantly more reads than writes or more writes than reads, you might need to change this setting to adjust the read/write cache ratio for improving performance. Reboot is required for the setting to take effect. The optimal ratio setting is application-dependent.

WEB BROWSER-BASED CONFIGURATION

● Dual Path Usage

This option is only available on the ARC-1883X with dual path firmware.

- **Load Balance By Slot** is the method for distributing command requests across a group of slots. Going down the list of slots, the controller forwards a command request to each slot in turn.
- **Load Balance By Round Robin** is the method for distributing command requests across two ports of each slot. Going down the list of ports in the slot, the controller forwards a command request to each port in turn.
- **Active Standby** is the method for distributing command requests on across the SFF-8644 SAS 1-4 ports and the other SFF-8644 SAS 5-8 ports as standby. If the active SAS cable fails, traffic fails over to a standby cable.

Areca Technology Corporation

[open all] [close all]

- Raid System Console
- Quick Function
- RAID Set Functions
- Volume Set Functions
- Security Functions
- Physical Drives
- System Controls
 - System Configuration
 - Advanced Configuration**
 - Hdd Power Management
 - EtherNet Configuration
 - Alert By Mail Configuration
 - SNMP Configuration
 - NTP Configuration
 - View Events/Mute Beeper
 - Generate Test Event
 - Clear Event Buffer
 - Modify Password
 - Upgrade Firmware
 - Information

Advanced Configurations	
TLER Setting	Default
Timeout Setting	8 Seconds
Number Of Retries	2
Buffer Threshold Setting	25%
Amount Of Read Ahead	Auto
Number Of AV Streams	6
Optimize AV Recording	Disabled
Read Performance Margin	No
Write Performance Margin	No
Read And Discard Parity Data	Disabled
Fail Disk For Any Timeout	Disabled
Hitachi SATA HDD Speed	Default
WDC SATA HDD Speed	Default
Seagate SATA HDD Speed	Default
BIOS Selection	Auto
PCIe Link Down Reset	Disabled
Active Cable Management	Auto
Host Command Queue Mode	Normal
End Device Frame Buffering	Enabled
PCIe Command Queue Depth	256
Write Cache Amount	Unified
Dual Path Usage	Load Balance By Slot
Int Connector#1 Speed Limit	Load Balance By Slot
Int Connector#2 Speed Limit	Load Balance By Round Robin
	Active Standby

Confirm The Operation

Submit Reset

WEB BROWSER-BASED CONFIGURATION

- **Ext Connector#1 Speed Limit**

This option is only available on the ARC-1883X/1883LP. It is used to limit the external connector speed in case of compatible issue on low speed connected enclosure.

- **Ext Connector#2 Speed Limit**

This option is only available on the ARC-1883X. It is used to limit the external connector speed in case of compatible issue on low speed connected enclosure.

6.9.3 HDD Power Management

Areca has automated the ability to manage HDD power based on usage patterns. The "HDD Power Management" allows you to choose a "Stagger Power On Control", "Low Power Idle", "Low RPM" and completely "Spins Down Idle HDD". It is designed to reduce power consumption and heat generation on idle drives.

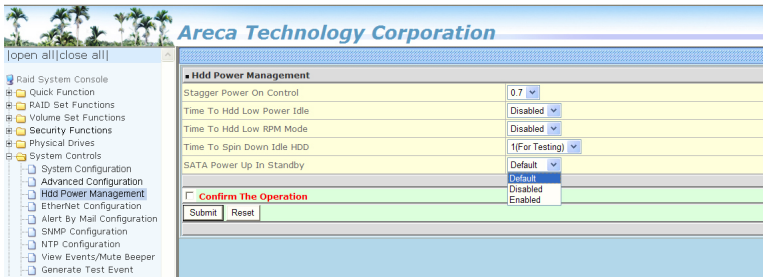

6.9.3.1 Stagger Power On Control

In a PC system with only one or two drives, the power can supply enough power to spin up both drives simultaneously. But in systems with more than two drives, the startup current from spinning up the drives all at once can overload the power supply, causing damage to the power supply, disk drives and other system components. This damage can be avoided by allowing the host to stagger the spin-up of the drives. The SAS/SATA drives have support stagger spin-up capabilities to boost reliability. Stagger spin-up is a very useful feature for managing multiple disk drives in a storage subsystem. It gives the host the ability to spin up the disk drives sequentially or in groups, allowing the drives to come ready at the optimum time without straining

WEB BROWSER-BASED CONFIGURATION

the system power supply. Staggering drive spin-up in a multiple drive environment also avoids the extra cost of a power supply designed to meet short-term startup power demand as well as steady state conditions.

Areca RAID controller has included the option for customer to select the disk drives sequentially stagger power up value. The values can be selected from 0.4 to 6 seconds per step which powers up one drive.

6.9.3.2 Time To Hdd Low Power Idle

This option delivers lower power consumption by automatically unloading recording heads during the setting idle time. The values can be selected "Disabled" or within the range 2 to 7 minutes.

6.9.3.3 Time To Hdd Low RPM Mode

This function can automatically spin disks at lower RPM if there have not been used during the setting idle time. The values can be selected "Disabled" or within the range 10 to 60 minutes.

6.9.3.4 Time To Spin Down Idle HDD

This function can automatically spin down the drive if it hasn't been accessed for a certain amount of time. This value is used by the drive to determine how long to wait (with no disk activity, before turning off the spindle motor to save power). The values can be selected "Disabled" or within the range 1 to 60 minutes.

6.9.3.5 SATA Power Up In Standby

SATA Power Up In Standby (power management 2 mode, PM2) is a SATA disk drive configuration which prevents the drive from automatic spinup when power is applied. "Enabled" option allows the drive to be powered-up into the Standby power management state to minimize inrush current at power-up and to allow the controller to sequence the spinup of devices. It is mainly for server/workstation environments operating in multiple-drive configurations.

WEB BROWSER-BASED CONFIGURATION

6.9.4 Ethernet Configuration

Use this feature to set the controller Ethernet port configuration. A customer doesn't need to create a reserved space on the arrays before the Ethernet port and HTTP service are working. The firm-ware-embedded web browser-based RAID manager can access it from any standard internet browser or from any host computer either directly connected or via a LAN or WAN with no software or patches required.

DHCP (Dynamic Host Configuration Protocol) is a protocol that lets network administrators manage centrally and automate the assignment of IP (Internet Protocol) configurations on a computer network. When using the internet's set of protocols (TCP/IP), in order for a computer system to communicate to another computer system, it needs a unique IP address. Without DHCP, the IP address must be entered manually at each computer system. DHCP lets a network administrator supervise and distribute IP addresses from a central point. The purpose of DHCP is to provide the automatic (dynamic) allocation of IP client configurations for a specific time period (called a lease period) and to eliminate the work necessary to administer a large IP network.

To configure the RAID controller Ethernet port, move the cursor bar to the main menu and click on the "System Controls" link. The "System Controls" menu will show all items. Move the cursor bar to the "Ethernet Configuration" item, then select the desired function.

The screenshot shows the web browser-based configuration interface for the RAID controller. The page title is "Areca Technology Corporation". The left sidebar contains a navigation menu with the following items: Raid System Console, Quick Function, RAID Set Functions, Volume Set Functions, Security Functions, Physical Drives, System Controls (expanded), System Configuration, Advanced Configuration, Hdd Power Management, Ethernet Configuration (selected), Alert By Mail Configuration, SNMP Configuration, NTP Configuration, View Events/Mute Beeper, Generate Test Event, Clear Event Buffer, Modify Password, Upgrade Firmware, and Information.

The main content area is titled "Ethernet Net Configurations" and contains the following configuration fields:

Field	Value
DHCP Function	Enabled
Local IP Address (Used If DHCP Disabled)	192.168.1.100
Gateway IP Address (Used If DHCP Disabled)	192.168.1.1
Subnet Mask (Used If DHCP Disabled)	255.255.255.0
HTTP Port Number (7168..8191 Is Reserved)	80
Telnet Port Number (7168..8191 Is Reserved)	23
SMTP Port Number (7168..8191 Is Reserved)	25
Current IP Address	192.168.0.103
Current Gateway IP Address	192.168.0.1
Current Subnet Mask	255.255.255.0
Ether Net MAC Address	00.1B.4D.40.00.51

At the bottom of the configuration area, there is a red warning message: "Confirm The Operation". Below the warning are two buttons: "Submit" and "Reset".

WEB BROWSER-BASED CONFIGURATION

Note:

If you configure the HTTP Port Number to 0, the HTTP console will be closed.

6.9.5 Alert By Mail Configuration

To configure the SAS RAID controller e-mail function, move the cursor bar to the main menu and click on the "System Controls" link. The "System Controls" menu will show all items. Move the cursor bar to the "Alert By Mail Configuration" item, then select the desired function. This function can only be set via web-based configuration.

The firmware contains a SMTP manager monitoring all system events. Single or multiple user notifications can be sent via "Plain English" e-mails with no software required. (Please refer to section 5.6 ArcHTTP Configuration of SMTP Server Configuration, Mail Address Configuration and Event Notification Configuration.)

The screenshot shows the web-based configuration interface for the Areca Technology Corporation. The interface is divided into a left sidebar menu and a main configuration area. The sidebar menu includes options like "Raid System Console", "Quick Function", "RAID Set Functions", "Volume Set Functions", "Physical Drives", "System Controls", "System Configuration", "Advanced Configuration", "HDD Power Management", "Ethernet Configuration", "Alert By Mail Configuration", "SMTP Configuration", "NTD configuration", "View Events/Mute Beeper", "Generate Test Event", "Clear Event Buffer", "Modify Password", "Upgrade Firmware", and "Information". The "Alert By Mail Configuration" option is selected. The main configuration area is titled "Alert By Mail Configuration" and is divided into three sections: "SMTP Server Configuration", "Mail Address Configurations", and "Event Notification Configurations".

SMTP Server Configuration

SMTP Server IP Address: [0] [0] [0] [0]

Mail Address Configurations

Sender Name: [] Mail Address: []

Account: [] Password: []

Event Notification Configurations

MailTo Name1: [] Mail Address: []

Disable Event Notification No Event Notification Will Be Sent

Urgent Error Notification Send Only Urgent Event

Serious Error Notification Send Urgent And Serious Event

Warning Error Notification Send Urgent, Serious And Warning Event

Information Notification Send All Event

Notification For No Event Notify User If No Event Occurs Within 24 Hours

MailTo Name2: [] Mail Address: []

Disable Event Notification No Event Notification Will Be Sent

Urgent Error Notification Send Only Urgent Event

Serious Error Notification Send Urgent And Serious Event

Warning Error Notification Send Urgent, Serious And Warning Event

Information Notification Send All Event

Notification For No Event Notify User If No Event Occurs Within 24 Hours

MailTo Name3: [] Mail Address: []

Disable Event Notification No Event Notification Will Be Sent

Urgent Error Notification Send Only Urgent Event

Serious Error Notification Send Urgent And Serious Event

Warning Error Notification Send Urgent, Serious And Warning Event

Information Notification Send All Event

Notification For No Event Notify User If No Event Occurs Within 24 Hours

MailTo Name4: [] Mail Address: []

Disable Event Notification No Event Notification Will Be Sent

Urgent Error Notification Send Only Urgent Event

WEB BROWSER-BASED CONFIGURATION

6.9.6 SNMP Configuration

Please refer to Appendix D of SNMP Operation & Installation.

The screenshot shows the 'SNMP Configuration' page in the Areca Technology Corporation web interface. The left sidebar contains a tree view with 'SNMP Configuration' selected. The main content area is divided into several sections:

- SNMP Trap Configurations:** A table with three rows for 'SNMP Trap IP Address #1', '#2', and '#3'. Each row has four input fields for IP address octets and a 'Port#' field set to '162'.
- SNMP System Configurations:** Fields for 'Community', 'sysContact.0', 'sysName.0', and 'sysLocation.0'.
- SNMP Trap Notification Configurations:** A list of checkboxes for various notification types: 'Disable SNMP Trap', 'Urgent Error Notification', 'Serious Error Notification', 'Warning Error Notification', 'Informational Notification', and 'SNMP Through PCI Inband'. Each checkbox is accompanied by a description of the event to be sent.
- Confirm The Operation:** A red header with 'Submit' and 'Reset' buttons.

6.9.7 NTP Configuration

The Network Time Protocol (NTP) is used to synchronize the time of a computer client or server to another server or reference time source, such as a radio or satellite receiver or modem. It provides accuracies typically within a millisecond on LANs and up to a few tens of milliseconds on WANs relative to Coordinated Universal Time (UTC) via a Global Positioning Service (GPS) receiver, for example:

The screenshot shows the 'NTP Configuration' page in the Areca Technology Corporation web interface. The left sidebar contains a tree view with 'NTP Configuration' selected. The main content area is divided into several sections:

- NTP Server Configurations:** A table with two rows for 'NTP Server IP Address #1' and '#2'. Each row has four input fields for IP address octets.
- Time Zone Configuration:** A dropdown menu for 'Time Zone' (set to '(GMT-12:00)International Date Line West') and a checkbox for 'Automatic Daylight Saving' (set to 'Enabled'). Below these are fields for 'Current Time' (2011/6/16 16:31:4) and 'NTP Server Not Set'.
- Confirm The Operation:** A red header with 'Submit' and 'Reset' buttons.

Note:

NTP feature works through onboard Ethernet port. So you must make sure that you have connected onboard Ethernet port.

WEB BROWSER-BASED CONFIGURATION

● NTP Server Address

The most important factor in providing accurate, reliable time is the selection of NTP servers to be used in the configuration file. Typical NTP configurations utilize multiple redundant servers and diverse network paths in order to achieve high accuracy and reliability. Our NTP configuration supports two existing public NTP synchronization subnets.

● Time Zone

Time Zone conveniently runs in the system tray and allows you to easily view the date and time in various locations around the world. You can also quickly and easily add your own personal locations to customize time zone the way you want.

● Automatic Daylight Saving

Automatic Daylight Saving will normally attempt to automatically adjust the system clock for daylight saving changes based on the computer time zone. This tweak allows you to disable the automatic adjustment.

6.9.8 View Events/Mute Beeper

To view the SAS RAID controller's event information, click on the "View Event/Mute Beeper" link. The SAS RAID controller "System events Information" screen appears. The mute beeper function automatically enable by clicking on "View Events/Mute Beeper".

The screenshot shows the Areca Technology Corporation web interface. The left sidebar contains a navigation menu with the following items: Raid System Console, Quick Function, RAID Set Functions, Volume Set Functions, Physical Drives, System Controls, System Configuration, Advanced Configuration, HDD Power Management, Ethernet Configuration, Alert By Mail Configuration, SNMP Configuration, NTP Configuration, View Events/Mute Beeper (highlighted), Generate Test Event, Clear Event Buffer, Modify Password, Upgrade Firmware, and Information.

The main content area displays the "System Events Information" table with the following columns: Time, Device, Event Type, and Elapse Time.

Time	Device	Event Type	Elapse Time
2011-06-16 15:16:20	192.168.000.090	HTTP Log In	
2011-06-16 15:00:04	Enc#2 SLOT 02	PassThrough Disk Created	
2011-06-16 14:56:59	Enc#2 SLOT 01	PassThrough Disk Created	
2011-06-16 14:52:04	192.168.000.090	HTTP Log In	
2011-06-16 14:50:56	192.168.000.164	HTTP Log In	
2011-06-16 14:46:46	Raid Set # 004	Delete RaidSet	
2011-06-16 14:46:44	Raid Set # 003	Delete RaidSet	
2011-06-16 14:46:43	Raid Set # 002	Delete RaidSet	
2011-06-16 14:46:41	Raid Set # 001	Delete RaidSet	
2011-06-16 14:46:41	Raid Set # 000	Delete RaidSet	
2011-06-16 14:46:30	ARC-1002-VOL#000	Complete Init	000:00:13
2011-06-16 14:46:37	ARC-1882-VOL#001	Abort Initialization	000:00:12
2011-06-16 14:46:28	RS232 Terminal	VT100 Log In	
2011-06-16 14:46:25	ARC-1882-VOL#000	Start Initialize	
2011-06-16 14:46:25	ARC-1882-VOL#001	Start Initialize	
2011-06-16 14:46:08	000:00000368F00	Restart Init LBA Point	
2011-06-16 14:46:04	001:0000000A8400	Restart Init LBA Point	
2011-06-16 14:46:04	H/W Monitor	Raid Powered On	
2011-06-16 14:37:59	RS232 Terminal	VT100 Log In	
2011-06-16 14:37:57	ARC-1882-VOL#000	Start Initialize	
2011-06-16 14:37:57	ARC-1882-VOL#001	Start Initialize	
2011-06-16 14:37:48	001:000000030400	Restart Init LBA Point	
2011-06-16 14:37:48	Incomplete RAID	Discovered	
2011-06-16 14:37:47	H/W Monitor	Raid Powered On	

WEB BROWSER-BASED CONFIGURATION

Select this option to view the system events information: Time, Device, Event Type, Elapse Time and Errors. The RAID controller does not have a built-in real time clock. The time information is the relative time from the system time setting. The maximum event no. is 256 per controller.

6.9.9 Generate Test Event

Use this feature is generate events for testing purposes.

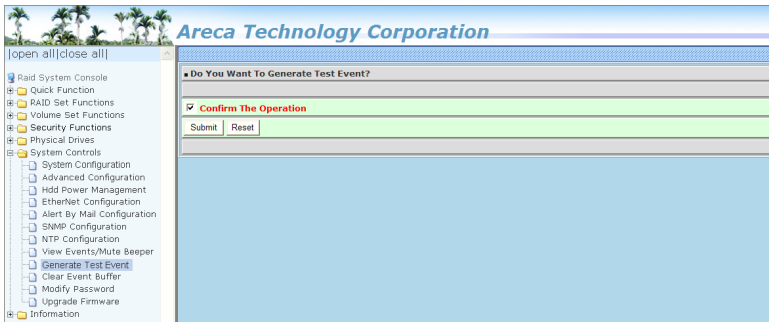

6.9.10 Clear Events Buffer

Use this feature to clear the entire events buffer information.

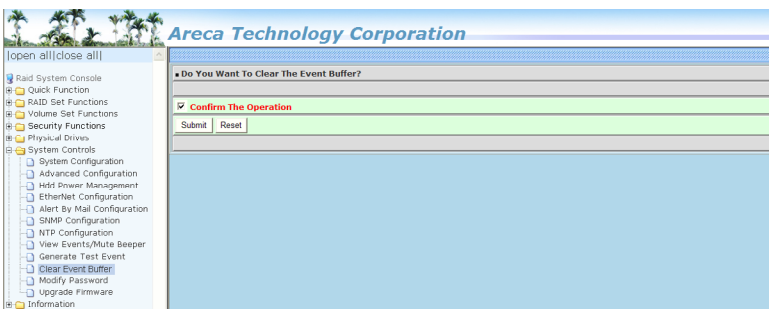

6.9.11 Modify Password

To set or change the SAS RAID controller password, select "System Controls" from the menu and click on the "Modify Password" link. The "Modify System Password" screen appears.

WEB BROWSER-BASED CONFIGURATION

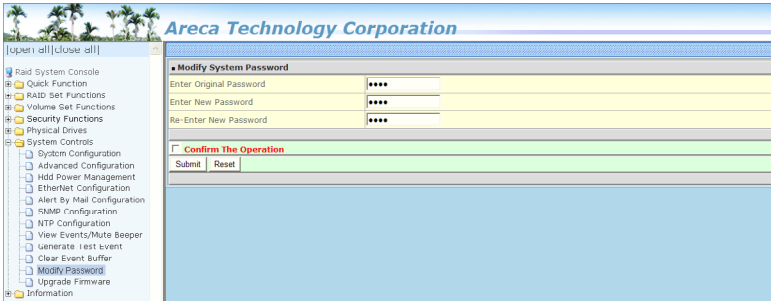

The manufacture default password is set to 0000.

The password option allows user to set or clear the SAS RAID controller's password protection feature. Once the password has been set, the user can only monitor and configure the SAS RAID controller by providing the correct password. The password is used to protect the SAS RAID controller from unauthorized entry. The controller will check the password only when entering the main menu from the initial screen. The SAS RAID controller will automatically go back to the initial screen when it does not receive any command in 5 minutes. Do not use spaces when you enter the password, If spaces are used, it will lock out the user. To disable the password, leave the fields blank. Once the user confirms the operation and clicks on the "Submit" button, the existing password will be cleared. Then, no password checking will occur when entering the main menu from the starting screen.

6.9.12 Update Firmware

Please refer to the appendix A "Upgrading Flash ROM Update Process".

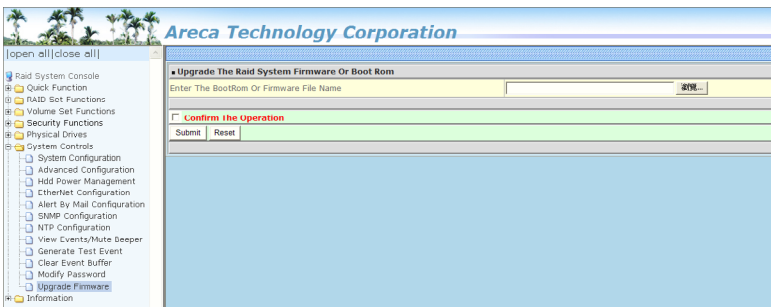

6.10 Information

6.10.1 Raid Set Hierarchy

Use this feature to view the SAS RAID controller current RAID set, current volume set and physical disk information. The volume state and capacity are also shown in this screen.

RaidSet Hierarchy

RAID Set	Devices	Volume Set (Ch/1d/1m)	Volume State	Capacity
Raid Set # 000	E#1Slot#1	Volume02 (0/0/0)	Normal	64.5GB
	E#1Slot#2			
	E#1Slot#3			
Raid Set # 001	E#1Slot#5	Volume03 (0/0/1)	Normal	64.5GB
	E#1Slot#6			
	E#1Slot#7			

Enclosure# 1 : SAS RAID Adapter V3.0

Device	Usage	Capacity	Model
Slot#1(A)	Raid Set # 000	6001.2GB	WDC WD6001F3V2-01SS780
Slot#2(B)	Raid Set # 000	6001.2GB	WDC WD6001F3V2-01SS780
Slot#3(C)	Raid Set # 000	6001.2GB	WDC WD6001F3V2-01SS780
Slot#4	N.A.	N.A.	N.A.
Slot#5(D)	Raid Set # 001	6001.2GB	WDC WD6002FRYZ-01WD580
Slot#6(E)	Raid Set # 001	6001.2GB	WDC WD6002FRYZ-01WD580
Slot#7(F)	Raid Set # 001	6001.2GB	WDC WD6002FRYZ-01WD580
Slot#8	N.A.	N.A.	N.A.

6.10.1.1 Hdd Xfer Speed

“Hdd Xfer Speed” is a firmware-level hard disk / SSD speed function that is used to measure the drive’s performance. “Hdd Xfer Speed” will perform read tests without overwriting customer data. The read-only palimpsest benchmark of the disk is shown in the device information. If the value drops below the normal curve, something may be wrong with the disk. User can use “Set Disk To Be Failed” function from remote side to set a slow speed disk as “failed” so that volume will be not stuck by the slow speed disk after rebuild.

“Hdd Xfer Speed” result can be accessed by clicking on the “Device” from the “RAID set Hierarchy” you wish to scan, clicking on the “Show Result”. This allows you to set up a scan environment which runs the test by clicking “Test Disk Speed” on the right screen setup option. If more than one drive is checked when you set the ‘Disks To Be Tested’, it will run that test for the number setting drives.

WEB BROWSER-BASED CONFIGURATION

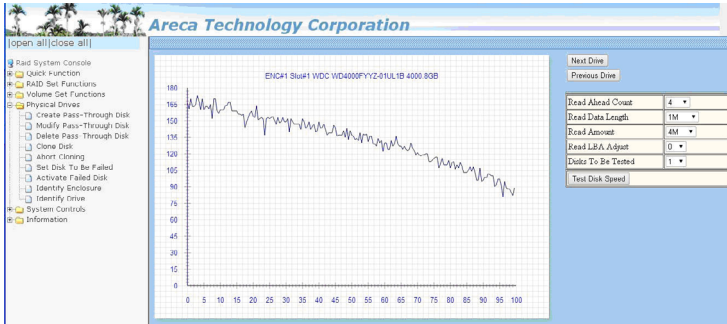

If there's a certain location in the hard drive that is getting poor performance, hard drive read benchmarks can help confirm this. Above is a screenshot of a palimpsest benchmark on a hard drive. The length time of firmware takes to complete the drive test depends on its size.

6.10.2 SAS Chip Information

To view the SAS RAID controller's SAS controller and attached expander chip information, move the mouse cursor to the main menu and click on the "SAS Chip Information" link. The SAS RAID controller "SAS Chip Information" screen appears.

The screenshot shows the "SAS Chip Information" page with the following details:

- Controller: Areca ARC-1003X 1.51**
 - SAS Address: N3B3429A9A98B1E01
 - Enclosure: ENC#1
 - Number of Phys: 0
 - Attached Expander: Expander#1[[5001B469A4C0C03F][4x6]]
 - Attached Expander: Expander#2[[5001B46920DC13F][4x12C]]
- Expander#1: Areca ARC-8016-00.00.b000**
 - SAS Address: 5001B469A4C0C03F
 - Component Vendor: LSI
 - Component ID: 0223
 - Enclosure: ENC#2
 - Number of Phys: 38
 - Attached Expander: Expander#3[[5001B469010483F][4x6]]
 - Attached Expander: Controller[[50004C9B5969F000][4x6C]]
- Expander#2: Areca ARC-8018D-09.09hJ09**
 - SAS Address: 5001B46920DC13F
 - Component Vendor: LSI
 - Component ID: 0223
 - Enclosure: ENC#3
 - Number of Phys: 38
 - Attached Expander: Controller[[50004C9B5969F000][4x12C]]
- Expander#3: Areca ARC-8016-01.13.0110**
 - SAS Address: 5001B469010483F
 - Component Vendor: LSI
 - Component ID: 0223
 - Enclosure: ENC#4
 - Number of Phys: 38
 - Attached Expander: Expander#1[[5001B469A4C0C03F][4x6C]]

User can click on ROC controller and SAS expander # item on the "SAS Chip Information" screen. It will show statistic page for ports on the ROC controller and SAS expander#. Click on the "Clear Error Log" to refresh the fully statistic page.

WEB BROWSER-BASED CONFIGURATION

6.10.3 System Information

To view the SAS RAID controller's system information, move the mouse cursor to the main menu and click on the "System Information" link. The SAS RAID controller "RAID Subsystem Information" screen appears. Use this feature to view the SAS RAID controller's system information. The controller name, controller firmware version, Boot ROM version, SAS firmware version, serial number, main processor, CPU instruction/data cache size, system memory size/speed and current IP address appear in this screen.

The screenshot shows the "RAID Subsystem Information" screen. The left sidebar contains a navigation menu with options like "Raid System Console", "Quick Function", "RAID Set Functions", "Volume Set Functions", "Security Functions", "Physical Drives", "System Controls", "Information", "RAID Set Hierarchy", "SAS Chip Information", "System Information", and "Hardware Monitor". The main content area displays the following information:

RAID Subsystem Information	
Controller Name	ARC-1883IX-24
Firmware Version	V1.54 2017-01-04
BOOT ROM Version	V1.54 2017-01-04
PL Firmware Version	13.0.0.0
Serial Number	ARC-1883-1X24PPP
Unit Serial #	
Main Processor	1.2GHz PPC476 RevCDE
CPU ICache Size	32KBytes
CPU DCache Size	32KBytes/Write Through
CPU SCache Size	512KBytes/Write Back
System Memory	4096MB/1333MHz/ECC
PCI-E Link Status	8X/8G
Current IP Address	192.168.0.105

6.10.4 Hardware Monitor

The hardware monitor information of the enclosure attached in this controller is also shown on this screen.

The screenshot shows the "Hardware Monitor" screen. The left sidebar is the same as in the previous screenshot. The main content area displays the following information:

Stop Auto Refresh

Controller H/W Monitor	
CPU Temperature	54 °C
Controller Temp.	40 °C
CPU Fan	6750 RPM
12V	12.342 V
5V	5.080 V
3.3V	3.312 V
IO Voltage +1.8V	1.840 V
DDR3 +1.5V	1.536 V
CPU VCore +0.9V	0.944 V
Ethermal +1.2V	1.232 V
DDR3 +0.75V	0.768 V
Battery Status	Not Installed

Enclosure#1 : SAS RAID Adapter V1.0

Enclosure#2 : Areca A1883Exp01.27.510127(A)	
Chip Temp	58 °C

APPENDIX

Appendix A

Upgrading Flash ROM Update Process

A-1 Overview

Since the SAS RAID controller features flash ROM firmware, it is not necessary to change the hardware flash chip in order to upgrade the RAID firmware. The user can simply re-program the old firmware through the in-band PCIe bus, out-of-band Ethernet port McRAID storage manager or nflash DOS utility. New releases of the firmware are available in the form of a DOS file on the shipped CD or Areca website. The files available at the FTP site for each model contain the following files in each version:

ARC1883NNNN.BIN Software Binary Code ("NNNN" refers to the software code type)

ARC1883BIOS.BIN :→ PCIe 3.0 BIOS for system board using

ARC1883BOOT.BIN :→ RAID controller hardware initialization

ARC1883FIRM.BIN :→ RAID kernel program

ARC1883MBR0.BIN:→ Master Boot Record for supporting Dual Flash Image in the 12Gb/s SAS RAID controller

README.TXT contains the history information of the software code change in the main directory. Read this file first to make sure you are upgrading to the proper binary file. Select the right file for the upgrade. Normally, user upgrades the ARC1883BIOS.BIN for system M/B compatibility and ARC1883FIRM.BIN for RAID function. All these files in the firmware package are a part of the firmware. You should update all files in the package, no special update order needed. New firmware works after a system restart not instantant available, so you can update all files before restart the system. The controller firmware is independent of the array, update firmware does not touch anything you stored in the array.

Note:

Please update all binary code (BIOS, BOOT FIRM and MBR0) before you reboot system. Otherwise, a mixed firmware package may result the controller hang.

A-2 Upgrading Firmware Through McRAID Storage Manager

Get the new version firmware for your SAS RAID controller. For example, download the bin file from your OEM's web site onto the C: drive.

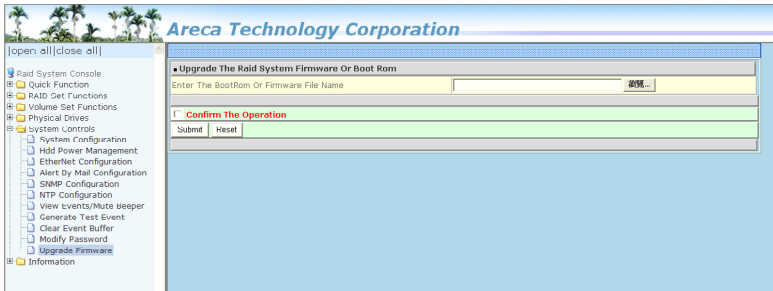

1. To upgrade the 12Gb/s SAS RAID controller firmware, move the mouse cursor to "Upgrade Firmware" link. The "Upgrade The Raid System Firmware or Boot Rom" screen appears.
2. Click on "Browse". Look in the location to which the Firmware upgrade software was downloaded. Select the file name and click on "Open".
3. Tick on "Confirm The Operation" and press the "Submit" button.
4. The web browser begins to download the firmware binary to the controller and start to update the flash ROM.
5. After the firmware upgrade is complete, a bar indicator will show "Firmware Has Been Updated Successfully".
6. After the new firmware package completes downloading, find a chance to restart the controller/computer for the new firmware to take effect.

The web browser-based McRAID storage manager can be accessed through the in-band PCIe bus or out-of-band LAN port. The in-band method uses the ArcHTTP proxy server to launch the McRAID storage manager. The out-of-band method allows local or remote to access the McRAID storage manager from any standard internet browser via a LAN or WAN with no software or patches required.

APPENDIX

Controller with onboard LAN port, you can directly plug an Ethernet cable to the controller LAN port, then enter the McBIOS RAID manager to configure the network setting. After network setting configured and saved, you can find the current IP address in the McBIOS RAID manager "System Information" page.

From a remote pc, you can directly open a web browser and enter the IP address. Then enter user name and password to login and start your management. You can find the firmware update feature from the "Raid system Console" on the "System Controls" option.

A-3 Upgrading Firmware Through nflash DOS Utility

Areca now offers an alternative means communication for the SAS RAID controller – Upgrade the all files (BIOS, BOOT, FIRM and MBR0) without necessary system starting up to running the ArchHTTP proxy server. The nflash utility program is a DOS application, which runs in the DOS operating system. Be sure of ensuring properly to communicate between SAS RAID controller and nflash DOS utility. Please make a bootable DOS floppy diskette or USB devices from other Windows operating system and boot up the system from those bootable devices.

• Starting the nflash Utility

You do not need to short any jumper cap on running nflash utility. The nflash utility provides an on-line table of contents, brief descriptions of the help sub-commands. The nflash utility put on the <CD-ROM>\Firmware directory. You can run the <nflash> to get more detailed information about the command usage. Typical output looks as below:

```
A:\nflash
Raid Controller Flash Utility
V1.52 2013-11-07
Command Usage:
NFLASH FileName
NFLASH FileName /cn --> n=0,1,2,3 write binary to controller#0
FileName May Be ARC1883FIRM.BIN or ARC1883*
For ARC1883* Will Expand To ARC1883BOOT /FIRM/BIOS.BIN
```

```
A:\>nflash arc188~1.bin
Raid Controller Flash Utility
V1.52 2013-11-07
MODEL : ARC-1883
MEM FE620000 FE7FF000
File ARC188~1.BIN : >>*** => Flash OK
```

A-4 Upgrading Firmware Through CLI

This Command Line Interface (CLI) provides you to configure and manage the 12Gb/s SAS RAID controller components in Windows, Linux, FreeBSD and more environments. The CLI is useful in environments where a graphical user interface (GUI) is not available. Through the CLI, you perform firmware upgrade that you can perform with the McRAID storage manager GUI. The controller has added protocol on the firmware for user to update the controller firmware package(BIOS, BOOT, FIRM and MBR0) through the utility.

To update the controller firmware, follow the procedure below:

```
Parameter: <path=<PATH_OF_FIRMWARE_FILE>>
Fn: Firmware Updating.
Ex: Update Firmware And File Path Is In [C:\FW\ARC1883FIRM.BIN.]
Command: sys updatefw path=c:\fw\arc1883firm.bin [Enter]
```

APPENDIX

Appendix B

Flash-based Backup Module (ARC-1883-BAT/CAP)

B-1 Overview

The ARC-1883-BAT/CAP kit includes the Flash-based module (FBM), and one cable. The FBM features NAND flash memory and super capacitor technology that provides cache offload capability to protect cached data in case of system power loss. The ARC-1883-CAP (Flash+Supercap) module is mounted super-capacitor pack that provides power for the backup of your data. The ARC-1883-BAT (Flash+LiOn Battery) module is mounted battery pack that provides power for the backup of your data. When the module detects loss of power, the super capacitor keeps parts of the ARC-8088 RAID controller active long enough to allow cache data to be copied to the flash memory. The module attaches directly to the 12 Gb/s SAS RAID controller by the cable.

B-2 FBM Components

The following figure provides the board layout and connector/jumper of the FBM.

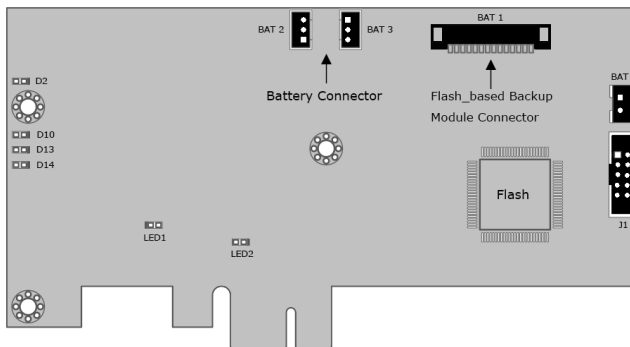

B-3 FBM Outline

The following figures provide the upper and top view of the FBM using supercap and battery.

1. FBM with SuperCap

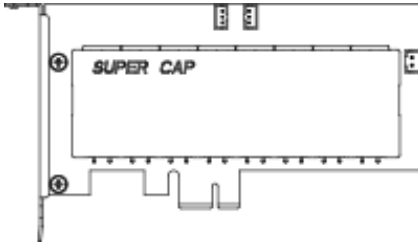

Figure B-1, ARC-1883-CAP
(top view)

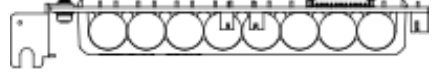

Figure B-2, ARC-1883-CAP
(upper view)

2. FBM with Battery

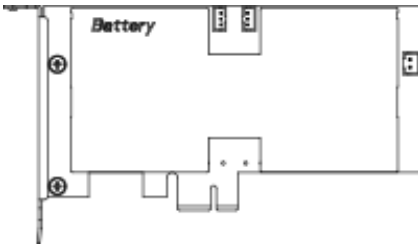

Figure B-3, ARC-1883-BAT
(top view)



Figure B-4, ARC-1883-BAT
(upper view)

B-4 Status of FBM

The following table provides the LED status of the FBM.

D2 (Blue)	Status
On	Power On
Off	Power Off

D14 (Blue)	Status
Charge	Slow Flash 1Hz
Charge-Done	On
Discharge	Quick Flash 10Hz

APPENDIX

D10 (Green)	Status
Normal	On (SuperCap)
Back-up	Quick Flash 10Hz
Restore	Slow Flash 1Hz
Normal	Off (Battery)

D13 (Red)	Status
Normal	Off
Fail	Quick Flash 10Hz
Calibration	Slow Flash 1Hz
Need Replace	On

Function	LED1 (Green)	LED2 (Green)
NAND Flash R/W	Flash	Flash

Note:

The FBM status will be shown on the web browser of "Hardware Monitor Information" screen.

B-5 Installation

Follow these steps to attach the flash-based backup module to the ARC-1883 RAID controller.

1. Turn off the system power, and unplug the power cords.
2. Remove the mounting screw and existing bracket from the rear panel behind the selected PCIe slot.
3. Insert the FBM in the PCIe slot and press down gently, but firmly, to ensure that the card is properly seated in the slot.
4. Screw the bracket into the computer chassis.
5. Remove the cable that is included in the ARC-1883-CAP/BAT kit box. The cable has a 14-pin connector on both ends.
6. Insert one end of the cable into the 14-pin cable connector on the 12Gb/s SAS RAID adapter and the other end into the 14-pin J4 cable connector on the FBM with super-capacitor packs, as shown in below figure.

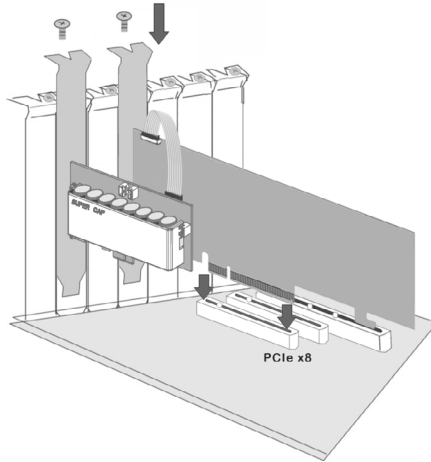

Note:

1. Low profile bracket also provided.
2. The FBM will occupy one PCI slot on the host backplane.

B-6 Flash-based Backup Capacity

The FBM backup capacity is defined as the maximum duration of a power failure for which data in the cache memory can be written into the flash on ARC-1883-CAP/BAT. The FBM can support up to 2GB memory chips that installed on the 12Gb/s SAS RAID controller.

B-7 Operation

1. There are no manual procedures for FBM conditioning or preconditioning to be performed by the user.
2. No further power is required once the super capacitor is fully charged.

Note:

Do not remove FBM while system is running.

APPENDIX

B-8 FBM Functionality Test Procedure:

1. Writing amount of data into controller volume, about 5GB or bigger.
2. Waiting for few seconds, power failed system by remove the power cable.
3. Power on system, and press Tab/F6 to login controller.
4. Check the controller event log, make sure the event shows "Power On With Battery Backup".

B-9 FBM Specifications

Mechanical

- Module Dimension (W x H x D):
 - with battery: 64.4 x 16.97 x 127 mm
 - with supercap: 64.4 x 18.72 x 127 mm
- BBM Connector: (1*14) box header

Environmental

- Operating Temperature: 0°C to +50°C
- Typical Life Expectancy: 5 years at 50°C
- Cache Memory Size Supported: up to 2GB (super capacitor/battery) or 8GB (battery)

Appendix C

Battery Backup Module (ARC-6120BA-T121-12G)

C-1 Overview

The 12Gb/s SAS RAID controller operates using cache memory. The Battery Backup Module is an add-on module that provides power to the 12Gb/s SAS RAID controller cache memory in the event of a power failure. The Battery Backup Module monitors the write back cache on the 12Gb/s SAS RAID controller, and provides power to the cache memory if it contains data not yet written to the hard drives when power failure occurs.

C-2 BBM Components

This section provides the board layout and connector/jumper for the BBM.

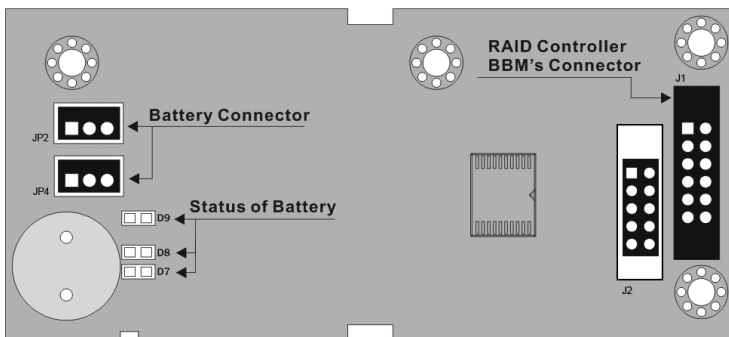

C-3 Status of BBM

- D7 (Green) : light when BBM activated
- D8 (Green) : light when BBM normal
- D9 (Red) : light when BBM charging

APPENDIX

Note:

The BBM status will be shown on the web browser of "Hardware Monitor Information" screen.

C-4 Installation

1. Make sure all power to the system is disconnected.
2. The 12Gb/s SAS RAID controller's battery connector is available for the optional battery backup module. Connect the BBM cable to the 14-pin battery connector on the controller.
3. Integrators may provide pre-drilled holes in their cabinet for securing the BBM using its three mounting positions.
4. Low profile bracket also provided.
5. The BBM will occupy one PCI slot on the host backplane.

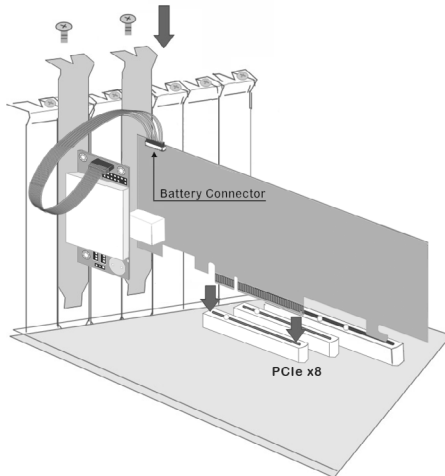

C-5 Battery Backup Capacity

Battery backup capacity is defined as the maximum duration of a power failure for which data in the cache memory can be maintained by the battery. The BBM's backup capacity varied with the memory chips that installed on the 12Gb/s SAS RAID controller.

C-6 Operation

1. Battery conditioning is automatic. There are no manual procedures for battery conditioning or preconditioning to be performed by the user.
2. In order to make sure of all the capacity is available for your battery cells, allow the battery cell to be fully charged when installed for the first time. The first time charge of a battery cell takes about 24 hours to complete.

C-7 Changing the Battery Backup Module

At some point, the LI-ION battery will no longer accept a charge properly. LI-ION battery life expectancy is anywhere from approximately 1 to 5 years.

1. Shutdown the operating system properly. Make sure that cache memory has been flushed.
2. Disconnect the BBM cable from 12Gb/s SAS RAID controller's battery connector.
3. Disconnect the battery pack cable from JP2 on the BBM.
4. Install a new battery pack and connect the new battery pack to JP2.
5. Connect the BBM to 12Gb/s SAS RAID controller's battery connector.

Note:

Do not remove BBM while system is running.

C-8 Battery Functionality Test Procedure:

1. Writing amount of data into controller volume, about 5GB or bigger.
2. Waiting for few seconds, power failed system by remove the power cable.
3. Check the battery status, make sure the D9 is bright light, and battery beeps every few seconds.
4. Power on system, and press Tab/F6 to login controller.
5. Check the controller event log, make sure the event shows controller boot up with power recovered.

APPENDIX

C-9 BBM Specifications

Mechanical

- Module Dimension (W x H x D): 37.3 x 13 x 81.6 mm
- BBM Connector: 2 x 6 box header

Environmental

- Operating Temperature
 - * Temperature:
 - 0° C to +40° C (Charge)
 - 0° C to +55° C (Discharge)
 - * Humidity: 45-85%, non-condensing
- Storage Temperature
 - * Temperature:
 - 20° C to +20° C (storing for less than 1year)
 - 20° C to +40° C (storing for less than 3months)
 - 20° C to +55° C (storing for less than 1month)
 - * Humidity: 45-85%, non-condensing

Electrical

- Input Voltage
 - +3.6VDC
- On Board Battery Capacity
 - 1880mAH (1 x 1880mAH) for ARC-1883 series boards

Appendix D

SNMP Operation & Installation

D-1 Overview

The McRAID storage manager includes a firmware-embedded Simple Network Management Protocol (SNMP) agent and SNMP Extension Agent for the Areca RAID controller. An SNMP-based management application (also known as an SNMP manager) can monitor the disk array. An example of a SNMP management application is Hewlett-Packard's Open View, Net-SNMP or SNMPc. The SNMP extension agent can be used to augment the Areca RAID controller if you are already running an SNMP management application at your site.

D-2 SNMP Definition

SNMP, an IP-based protocol, has a set of commands for getting the status of target devices. The SNMP management platform is called the SNMP manager, and the managed devices have the SNMP agent loaded. Management data is organized in a hierarchical data structure called the Management Information Base (MIB). These MIBs are defined and sanctioned by various industry associations. Each type of device on your network has its own specific MIB file. The MIB file defines the device as a set of managed objects — values that can be read or changed by the SNMP manager. The MIB file enables the SNMP manager to interpret trap messages from devices. To make sense out of a trap that's sent by a device, the SNMP manager needs to have access to the MIB that describes the format and content of the possible traps that the device can send. The objective is for all vendors to create products in compliance with these MIBs so that inter-vendor interoperability can be achieved. To be available for the SNMP manager, a command adds the MIB file for each of devices to the MIB database. This enables the devices to be managed via the SNMP manager.

The following figure illustrates the various components of an SNMP-based management architecture.

APPENDIX

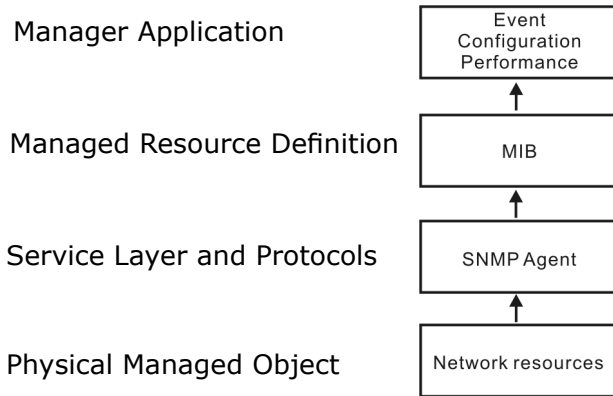

D-3 SNMP Installation

Perform the following steps to install the Areca RAID controller SNMP function into the SNMP manager. The installation of the SNMP manager is accomplished in several phases:

Step 1. Installing the SNMP manager software on the client

Installing the SNMP manager software on the client. This installation process is well-covered in the User's Guide of your SNMP manager application.

Step 2. Compiling the MIB description file with the management

Placing a copy of the RAID controller's MIBs file in a directory which is accessible to the management application and compile the MIB description file with the SNMP management application database. Before the manager application accesses the Areca RAID controller, it is necessary to integrate the MIB into the management application's database of events and status indicator codes. This process is known as "compiling" the MIB into the application. This process is highly vendor-specific and should be well-covered in the User's Guide of your SNMP manager application. Ensure the compilation process successfully integrates the contents of the `areca_sas.mib` file into the traps database. The MIBs file resides at: `<CD-ROM>\packages\SNMP_MIBs` on the software CD or download from <http://www.areca.com.tw>.

Each RAID controller needs to have its own MIBs file. Areca provide 4 adapters MIBs file for users. User can request it if more controllers install on one system.

Note:

1. The MIB compiler may be not installed by default with SNMP manager.
2. Some SNMP managers have unique rule on the format of MIB files, you may need to refer the error message to modify the mib file to be able to met the software requirement.

Step 3. SNMP Service Method

With Areca series RAID cards, there are 3 service methods to get snmp:
ArchHTTP, Onboard NIC and in-band PCIe + SNMP extension agent.

1. Service Method-1: using ArchHTTP Proxy Server
Pay attention to these:
 - Do not check mark the option: "SNMP Through PCI".
 - Make sure you have the latest driver and ArchHTTP, from this URL "<http://www.areca.com.tw/support/main.htm>".
 - ArchHTTP supports sending "traps" only, do not support the "get" command.
2. Service Method-2: using Onboard NIC.
Pay attention to these:
 - Do not check mark the option: "SNMP Through PCI".
 - Do need to fill out the "SNMP Trap Config".
3. Service Method-3: using in-band PCI + SNMP extension agent.
Pay attention to these:
 - Download the snmp extension agent from Areca URL.
 - The agent is to be installed on the system which has the Areca card.
 - Check Mark the option: "SNMP Through PCI".
 - To use in-band PCIe host bus interface, keep space (or zero) on all "SNMP Tarp IP Address" options.

APPENDIX

D-3-1 Using ArchHTTP

The HTTP management software (ArchHTTP) runs as a service or daemon, and have it automatically start the proxy for all controllers found. This way the controller can be managed remotely without having to sign in the server. The HTTP management software (ArchHTTP) also has integrated the ability of sending SNMP trap. Please reference chapter 5. ArchHTTP Proxy Server Installation section to install it. The ArchHTTP proxy server will automatically assign one additional port for setup its configuration. If you want to change the "archttpsrv.conf" setting up of ArchHTTP proxy server configuration, for example: General Configuration, Mail Configuration, and SNMP Configuration, please start Web Browser <http://localhost: Cfg Assistant>. Such as <http://localhost: 81>. The port number for the first controller McRAID storage manager is ArchHTTP proxy server configuration port number plus 1.

To enable the controller to send the SNMP traps to client SNMP manager using the IP address assigned to the operating system, such as Net-SNMP manager, you can simply use the SNMP function on the ArchHTTP proxy server software. To enable the RAID controller SNMP traps sending function, click on the "SNMP Configuration" link. The ArchHTTP proxy only provide one direction to send the trap to the SNMP manager without needing to install the SNMP extension agent on the host. If SNMP manager requests to query the SNMP information from RAID controller, please refer the D-3-2 section. Using Onboard NIC and D-3-3 section. Using in-band PCI + SNMP extension agent.

For detailed information on using ArchHTTP to send the SNMP traps, please see SNMP Traps Configuration section on 5.6 ArchHTTP Configuration.

Note:

Event Notification Table refers to Appendix E. After you confirm and submit configurations, you can use "Generate Test Event" feature to make sure these settings are correct.

D-3-2 Using Onboard NIC Installation

By using the built-in LAN port on the RAID controller- RAID controller using built-in LAN interface. You can use the browser-based manager or CLI SNMP configuration to setup the firmware-based SNMP configuration. The following screen is the firmware-embedded SNMP configuration setup screen using browser-based manager:

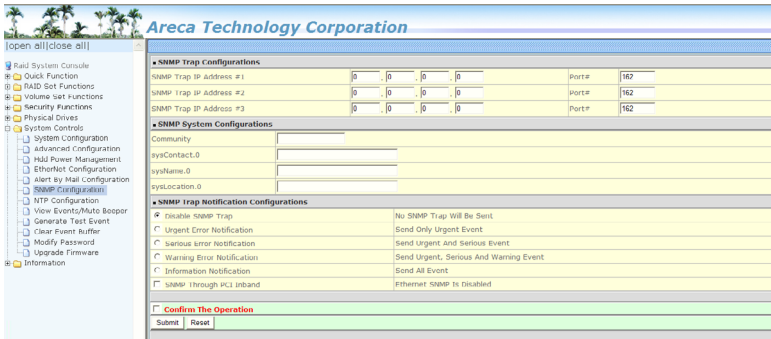

To launch the above browser-based RAID controller SNMP function, click on the “System Controls” link. The “System Controls” menu will show available items. Select the “SNMP Configuration” item. The firmware-embedded SNMP agent manager monitors all system events and the SNMP function becomes functional with no agent software required. The following article describes a best practice methodology for setting this up in the “SNMP Traps Configurations”.

1. SNMP Trap Configurations

Enter the SNMP Trap IP Address.

2. SNMP System Configurations

Community name acts as a password to screen accesses to the SNMP agent of a particular network device. Type in the community names of the SNMP agent. Before access is granted to a request station, this station must incorporate a valid community name into its request; otherwise, the SNMP agent will deny access to the system. Most network devices use “public” as default of their community names. This value is case sensitive. The system Contact, Name and Location that will be shown in the outgoing SNMP trap.

APPENDIX

3. SNMP Trap Notification Configurations

Please refer to Appendix E of Event Notification Configurations.

D-3-3 Using In-band PCI + SNMP Extension Agent Installation

By using the IP address assigned to the operating- RAID controller using Areca SNMP extension agent through PCIe host bus interface.

1. Set only "Community" field and select the "SNMP Port" option on the firmware-embedded SNMP configuration function. There is no function to set other fields on "SNMP System Configuration".

The SNMP community and SNMP port can setup by using browser-based manager or CLI SNMP configuration. To launch the above browser-based RAID controller SNMP function, click on the "System Controls" link. The "System Controls" menu will show available items. Select the "SNMP Configuration" item. The following "SNMP System Configuration" screen is launched by browser-based manager.

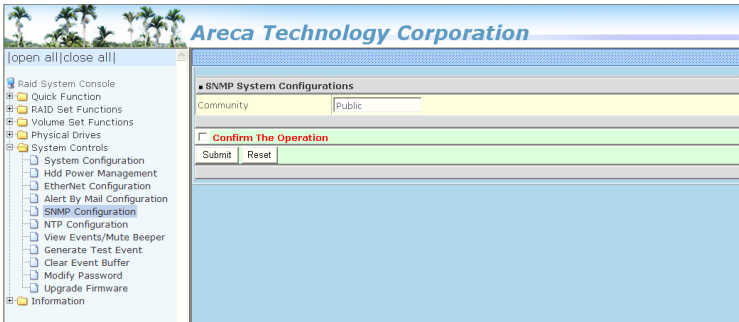

About community, Community name acts as a password to screen accesses to the SNMP agent of a particular network device. Type in the community names of the SNMP agent. Before access is granted to a request station, this station must incorporate a valid community name into its request; otherwise, the SNMP agent will deny access to the system. Most network devices use "public" as default of their community names. This value is case-sensitive.

2. Mark the check box on the "SNMP Through PCI Inband" setting and keep space (or zero) on all "SNMP Tarp IP Address" options.
3. Installing the SNMP extension agent on the server.
Please refer to next section of SNMP Extension Agent Installation for different operation system such as Windows, Linux and FreeBSD.

D-3-4 SNMP Extension Agent Installation

The SNMP extension agent on the device is able to return meaningful, highly useful information to the SNMP manager. The Areca RAID controllers have supported the extension agent for Windows, Linux and FreeBSD. This section is the detail procedures for those extension agent installation.

D-3-4-1 Windows

You must have administrative level permission to install SAS RAID controller extension agent software. This procedure assumes that the RAID hardware and Windows are both installed and operational in your system. To enable the SNMP agent for Windows, configure Windows for TCP/IP and SNMP services. The Areca SNMP extension agent file is ARCSNMP.DLL.

Screen captures in this section are taken from a Windows XP installation. If you are running another version of Windows, your screens may look different, but the Areca SNMP extension agent installation is essentially the same.

1. Insert the Areca RAID controller software CD in the CD-ROM drive.
2. Double-click on the setup.exe file that resides at: <CD-ROM>\packages\windows\SNMP on the CD. (If SNMP service was not installed, please install SNMP service first.)

APPENDIX

3. The screen shows Preparing to Install.

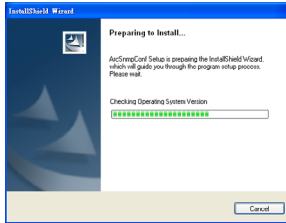

4. The InstallShield Wizard opens, preparing to install and click on the "Next" button to continue.

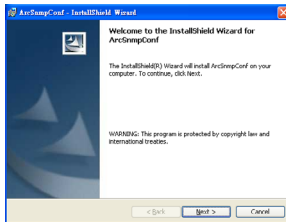

Follow the on-screen prompts to continue the Areca SNMP extension agent installation.

5. When you reach the installation page, click on the "Install" button to continue.

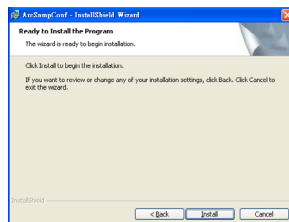

6. A Progress bar appears that measures the progress of the SNMP extension agent setup. When this screen completes, you have completed the Areca SNMP extension agent setup.

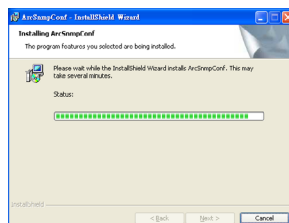

7. After a successful installation, the "Setup Complete" dialog box of the installation program is displayed. Click on the "Finish" button to complete the installation.

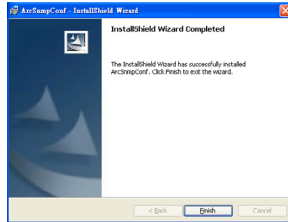

• Starting SNMP Trap Notification Configurations

To start "SNMP Trap Notification Configurations", There have two methods.

1. First, double-click on the "Areca RAID Controller".



2. Second, you may also use the "Taskbar Start/programs/ Areca Technology Corp/ArcSnpmConf" menus shown below.

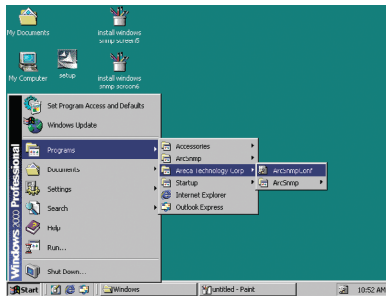

• SNMP Community Configurations

About community, Community name acts as a password to screen accesses to the SNMP agent of a particular network device. Type in the community names of the SNMP agent. Before access is granted to a request station, this station must incorporate a valid community name into its request; otherwise, the SNMP agent will deny access to the system. Most network devices use "public" as default of their community names. This value is case-sensitive.

APPENDIX

● SNMP Trap Notification Configurations

The "Community Name" should be the same as firmware-embedded SNMP Community. The "SNMP Trap Notification Configurations" includes level 1: Serious, level 2: Error, level 3: Warning and level 4: Information. The level 4 covers notification events such as initialization of the controller and initiation of the rebuilding process; Level 3 includes events which require the issuance of warning messages; Level 2 covers notification events which once have happen; Level 1 is the highest level, and covers events the need immediate attention (and action) from the administrator.

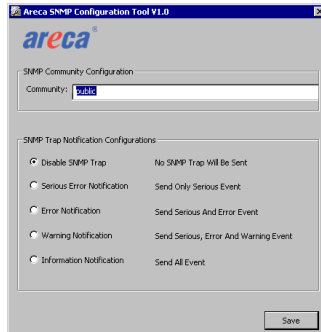

D-3-4-2 Linux

You must have administrative level permission to install Areca RAID software. This procedure assumes that the Areca RAID hardware and Linux are installed and operational in your system. The old version agent has to modify the open source project, integrate the changes from Areca manually, then take the modified binaries and manually deploy them. Users need to change source code from the linux distribution and then maintain it by themselves.

The new version agent provides the way to integrate with those codes into snmpd/snmptrapd and create a sub-agent for user easy to install it. The new version SNMP extension agent installation for Linux procedure, please refer to <CD-ROM>\packages\Linux\SNMP\readme.txt or download from ftp://ftp.areca.com.tw/RaidCards/AP_Drivers/Linux/SNMP/V4.1/ .

D-3-4-3 FreeBSD

You must have administrative level permission to install Areca RAID software. This procedure assumes that the Areca RAID hardware and FreeBSD are installed and operational in your system. The old version agent has to modify the open source project, integrate the changes from Areca manually, then take the modified binaries and manually deploy them. Users need to change source code from the linux distribution and then maintain it by themselves.

The new version agent provides the way to integrate with those codes into snmpd/snmptrapd and create a sub agent for user easy to install it. The new version SNMP extension agent installation for FreeBSD procedure, please refer to <CD-ROM>\packages\FreeBSD\SNMP\readme.txt or download from ftp://ftp.areca.com.tw/RaidCards/AP_Drivers/FreeBSD/SNMP/V4.1/.

APPENDIX

Appendix E

Event Notification Configurations

The controller classifies disk array events into four levels depending on their severity. These include level 1: Urgent, level 2: Serious, level 3: Warning and level 4: Information. The level 4 covers notification events such as initialization of the controller and initiation of the re-building process; Level 2 covers notification events which once have happen; Level 3 includes events which require the issuance of warning messages; Level 1 is the highest level, and covers events that need immediate attention (and action) from the administrator. The following lists sample events for each level:

A. Device Event

Event	Level	Meaning	Action
Device Inserted	Warning	HDD inserted	
Device Removed	Warning	HDD removed	
Reading Error	Warning	HDD reading error	Keep Watching HDD status, may be it caused by noise or HDD unstable.
Writing Error	Warning	HDD writing error	Keep Watching HDD status, may be it caused by noise or HDD unstable.
ATA Ecc Error	Warning	HDD ECC error	Keep Watching HDD status, may be it caused by noise or HDD unstable.
Change ATA Mode	Warning	HDD change ATA mode	Check HDD connection
Time Out Error	Warning	HDD time out	Keep Watching HDD status, may be it caused by noise or HDD unstable.
Device Failed	Urgent	HDD failure	Replace HDD
PCI Parity Error	Serious	PCI parity error	If only happen once, it may be caused by noise. If always happen, please check power supply or contact to us.
Device Failed(SMART)	Urgent	HDD SMART failure	Replace HDD
PassThrough Disk Created	Inform	Pass Through Disk created	
PassThrough Disk Modified	Inform	Pass Through Disk modified	
PassThrough Disk Deleted	Inform	Pass Through Disk deleted	

B. Volume Event

Event	Level	Meaning	Action
Start Initialize	Warning	Volume initialization has started	
Start Rebuilding	Warning	Volume rebuilding has started	
Start Migrating	Warning	Volume migration has started	
Start Checking	Warning	Volume parity checking has started	
Complete Init	Warning	Volume initialization completed	
Complete Rebuild	Warning	Volume rebuilding completed	
Complete Migrate	Warning	Volume migration completed	
Complete Check	Warning	Volume parity checking completed	
Create Volume	Warning	New volume created	
Delete Volume	Warning	Volume deleted	
Modify Volume	Warning	Volume modified	
Volume Degraded	Urgent	Volume degraded	Replace HDD
Volume Failed	Urgent	Volume failure	
Failed Volume Revived	Urgent	Failed volume revived	
Abort Initialization	Warning	Initialization been abort	
Abort Rebuilding	Warning	Rebuilding aborted	
Abort Migration	Warning	Migration aborted	
Abort Checking	Warning	Parity check aborted	
Stop Initialization	Warning	Initialization stopped	
Stop Rebuilding	Warning	Rebuilding stopped	
Stop Migration	Warning	Migration stopped	
Stop Checking	Warning	Parity check stopped	

C. RAID Set Event

Event	Level	Meaning	Action
Create RaidSet	Warning	New RAID set created	
Delete RaidSet	Warning	Raidset deleted	
Expand RaidSet	Warning	Raidset expanded	
Rebuild RaidSet	Warning	Raidset rebuilding	
RaidSet Degraded	Urgent	Raidset degraded	Replace HDD

APPENDIX

D. Hardware Monitor Event

Event	Level	Meaning	Action
DRAM 1-Bit ECC	Urgent	DRAM 1-Bit ECC error	Check DRAM
DRAM Fatal Error	Urgent	DRAM fatal error encountered	Check the DRAM module and replace with new one if required.
Controller Over Temperature	Urgent	Abnormally high temperature detected on controller	Check air flow and cooling fan of the enclosure, and contact us.
Hdd Over Temperature	Urgent	Abnormally high temperature detected on Hdd	Check air flow and cooling fan of the enclosure.
Fan Failed	Urgent	Cooling Fan # failure or speed below 1700RPM	Check cooling fan of the enclosure and replace with a new one if required.
Controller Temp. Recovered	Serious	Controller temperature back to normal level	
Hdd Temp. Recovered	Serious	HDD temperature back to normal level	
Raid Powered On	Warning	RAID power on	
Test Event	Urgent	Test event	
Power On With Battery Backup	Warning	RAID power on with battery backup	
Incomplete RAID Discovered	Serious	Some RAID set member disks missing before power on	Check disk information to find out which channel missing.
HTTP Log In	Serious	a HTTP login detected	
Telnet Log	Serious	a Telnet login detected	
InVT100 Log In	Serious	a VT100 login detected	
API Log In	Serious	a API login detected	
Lost Rebuilding/ MigrationLBA	Urgent	Some rebuilding/ migration raidset member disks missing before power on.	Reinserted the missing member disk back, controller will continue the incompleting rebuilding/ migration.

Appendix F

Self-Encrypting Disk (SED) Encryption

The “Security Function” on the firmware supports Self-Encrypting Disks (SED) for protection of data against loss or theft of SEDs. Protection is achieved by the use of encryption technology on the drives. The McRAID storage management allows SED keys to be created and managed as well as create/delete RAID sets.

Self-Encrypting Disk (SED) Encryption Flow Chart

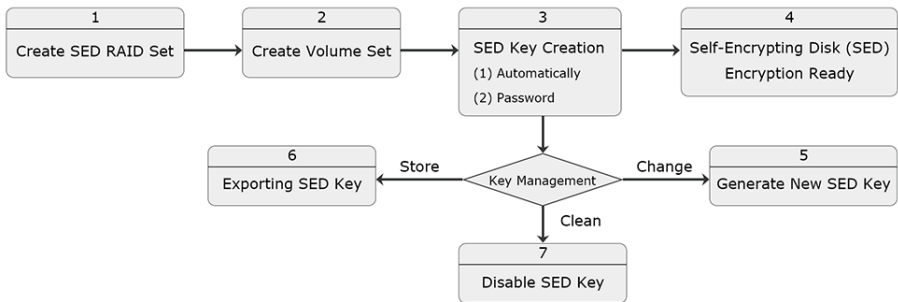

Step 1. Create SED RAID Set



APPENDIX

Step 2. Create Volume Set

Create volume set in the web management.

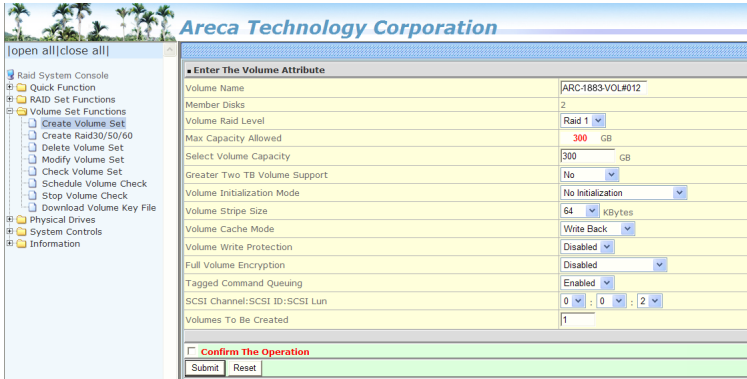

Step 3. SED Key Creation

There is one SED key per controller. You can create the SED key under McRAID manager. The key can be escrowed in to a file using McRAID manager. There is one SED key per controller which stores in the controller flash memory. Areca provides both automatically or password methods to generate a key.



Step 4. Self-Encrypting Disk (SED) Ready

Now, whenever you write data to the drive (e.g. create a file and save it to the SED volume), it gets encrypted with the SED key. And whenever you read data from the drive (e.g. access a file stored on the SED), it's decrypted with the same SED key.

Step 5. Generate New SED Key

If you have evidence that the SED key is known to unauthorized users, you can change the SED key again. Areca provides both automatically or password methods to generate a New key to replace the foreign SED key.

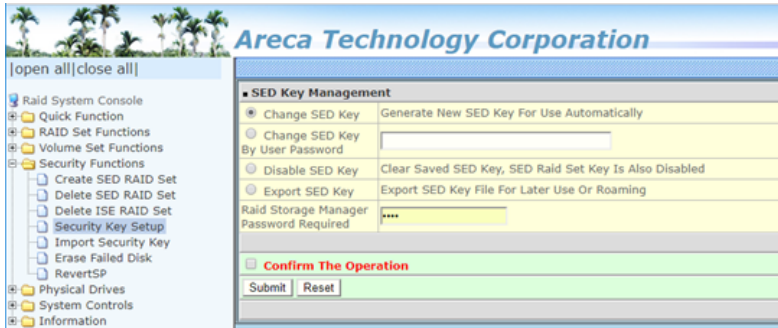

Step 6. Exporting SED Key

In some cases, you may want to export a SED key to store on removable media or to use on a different computer. If you want to create a backup copy of the SED key or use it on another computer, you must first export the SED key.



APPENDIX

Exporting the SED key puts it in a file (SEDKEY256.BIN) that you can then transfer to another computer or put in a safe place.

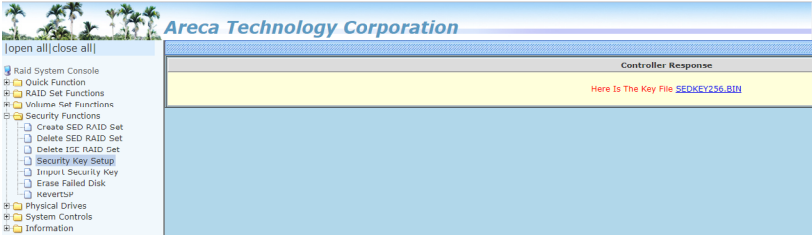

The key file (SEDKEY256.BIN) is stored on the specific location.

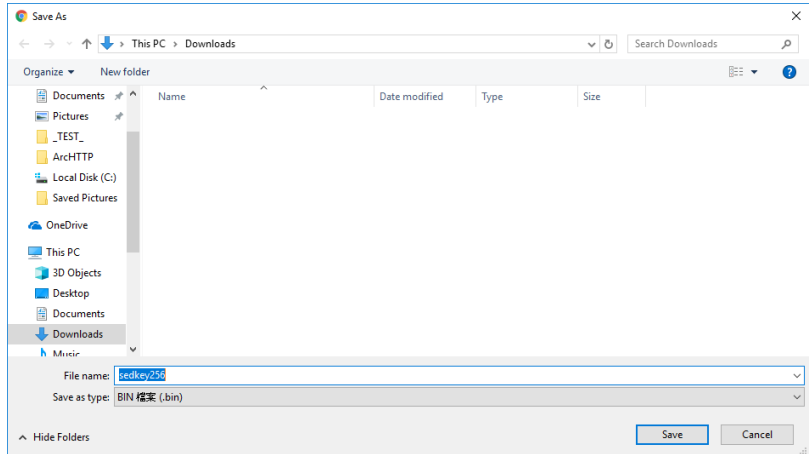

Without the proper authentication key (SED key), even if the SED RAID set is removed and placed in another new RAID controller, the data remains inaccessible.

Step 7. Clean Saved SED Key

The 'Disable SED Key' function is used to clear SED key on controller and RAID set members.

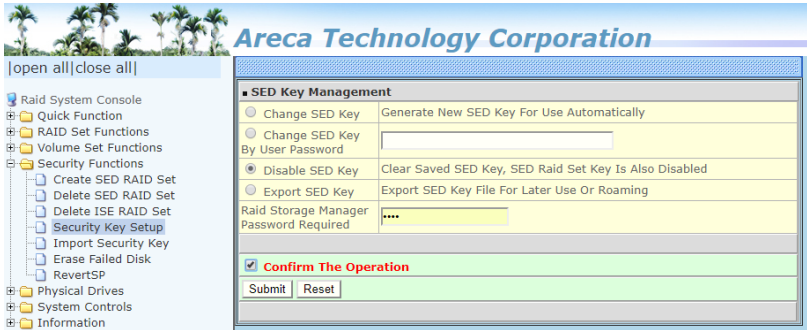

● Save SEDKey In Controller

There is one SED key per controller which stores in the controller flash memory. You can disable the SED Key saved in controller flash using "Save SEDKey In Controller" on the Advanced Configurations. So that next time power up again, it will ask for key again.

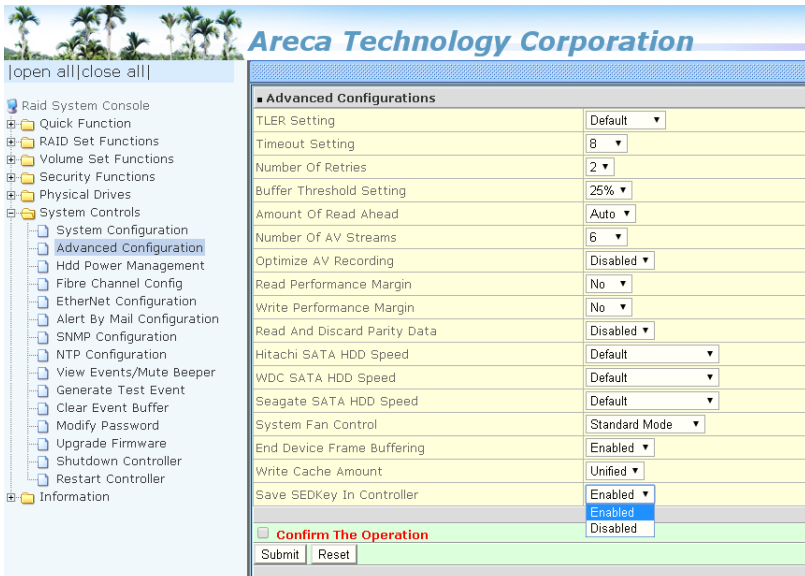

APPENDIX

- <a> If enable --> disable, clear SED Key saved in setup
- If disable --> enable, if key exists, save to setup

If you setup from enable--->disable, the key will not remain in the flash. So that next time power up again, it will need to input the key from the CLI or McRAID manager again. The controller volume will be in the lock stage. It will be not available to the OS.

After your run the CLI to upload the key, volume will be unlocked and available to the OS. You can also import the key file (Import Security Key) or keyin the password (Enter SED Key By User Password) from the GUI interface.

(1) Import Security Key



(2) Enter SED Key By User Password

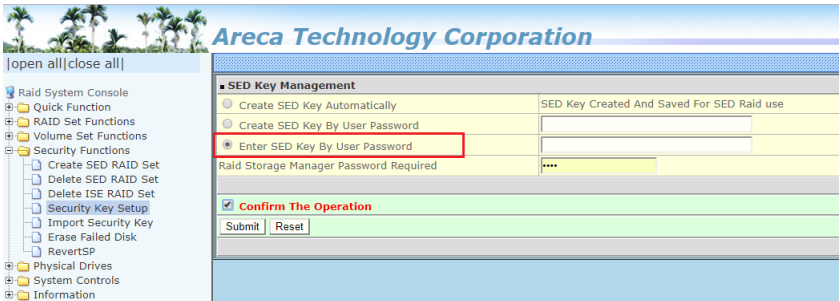

Appendix G

Full Volume Encryption

ARC-1882/1883 RAID adapters have featured with controller based hardware encryption function. Controller based hardware encryption describes the encryption of data occurring at the disk array controller before being sent to the disk drives. The hardware encryption does not impact the performance of ARC-1882/1883 RAID controller and can implement on any kinds of HDD that is transparent to the user, the OS, and applications. You can follow below steps to enable the function.

Full Volume Encryption Flow Chart

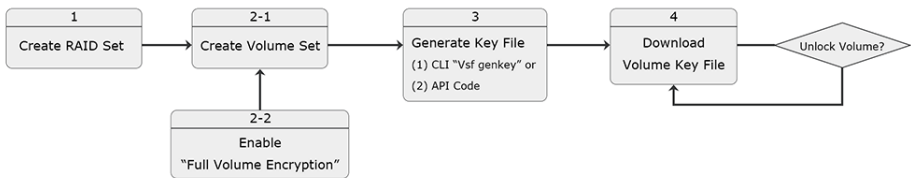

Step 1. Create RAID Set

Areca Technology Corporation

RAID System Console

RAID Set Functions

- Create RAID Set
- Delete RAID Set
- Expand RAID Set
- Offline RAID Set
- Rename RAID Set
- Activate Incomplete RAID Set
- Create Hot Spare
- Delete Hot Spare
- Rescue Raid Set

Volume Set Functions

Security Functions

Physical Drives

System Controls

Information

Select The Drives For RAID Set

Enclosure#1 : SAS RAID Adapter V3.0

Slot#	Capacity	Model
<input checked="" type="checkbox"/> Slot#1	6001.2GB	WDC WD6001FSYZ-01SS7B0
<input checked="" type="checkbox"/> Slot#2	6001.2GB	WDC WD6NPURX-64JC5Y0
<input checked="" type="checkbox"/> Slot#3	4000.8GB	SEAGATE ST4000NM0023
<input checked="" type="checkbox"/> Slot#4	1000.2GB	SEAGATE ST310004245S
<input checked="" type="checkbox"/> Slot#5	2000.4GB	TOSHIBA MK2001TRKB
<input checked="" type="checkbox"/> Slot#6	1000.2GB	ST1000DM003-9YN162
<input checked="" type="checkbox"/> Slot#7	2000.4GB	HITACHI HDS722020BLA642
<input checked="" type="checkbox"/> Slot#8	6001.2GB	WDC WD60EFRX-68L0BN1

RAID Set Name: Raid Set # 000

RAID Set Mode: Max 128 Volumes

Confirm The Operation

Submit | Reset

APPENDIX

Step 2. Create Volume and Enable “Full Volume Encryption”

Create volume set with “Full Volume Encryption” capability in the web management.

The screenshot shows the 'Enter The Volume Attribute' configuration page for a volume set. The 'Full Volume Encryption' option is highlighted with a red box. The configuration includes the following details:

Attribute	Value
Volume Name	ARC-1883-VOL#000
Member Disks	8
Volume Raid Level	Raid 0
Max Capacity Allowed	8000 GB
Select Volume Capacity	8000 GB
Greater Two TB Volume Support	64bit LBA
Volume Initialization Mode	No Initialization
Volume Stripe Size	64 KBytes
Volume Cache Mode	Write Back
Volume Write Protection	Disabled
Full Volume Encryption	Enabled
Tagged Command Queuing	Disabled
SCSI Channel:SCSI ID:SCSI Lun	256Bit Key, Password
Volumes To Be Created	128Bit Key, Password
	128Bit Key, AES Key

At the bottom, there is a 'Confirm The Operation' checkbox which is checked, and 'Submit' and 'Reset' buttons.

ARC-1883 adapters provide five new key options in the 'Full Volume Encryption': "Disable", "256Bit key, Password", "256Bit key, AES", "128Bit key, Password", "128Bit key, AES".

In the Volume Set Information, it is recorded "Encrypted, Locked" status.

The screenshot shows the 'Volume Set Information' page for the volume set. The 'Encrypted, Locked' status is highlighted with a red box. The information includes the following details:

Attribute	Value
Volume Set Name	ARC-1883-VOL#000
Volume Serial	42fbb1314134367
Raid Set Name	Raid Set # 000
Volume Capacity	8000,0GB (0x3A3520000)
SCSI Ch/Id/Lun	0/0/0
Raid Level	Raid 0
Stripe Size	64KBytes
Block Size	512Bytes
Member Disks	8
Cache Mode	Write Back
Write Protection	Disabled
Volume Encryption	Encrypted, Locked
Tagged Queuing	Enabled
Stripe Info	0000000000(00003A3521),0000000000(00003A3521)
Volume State	Normal

The encrypted volume is not visible in the system Disk Management.

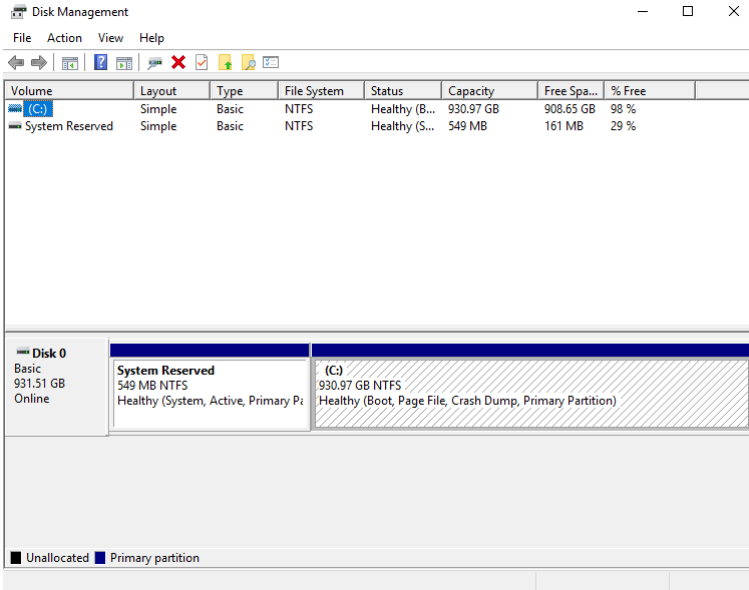

Step 3. Generate Key File

You can generate the new key by CLI utility or API code function.

```
CLI> vsf genkey path=C:\key
Key Information: C:\key

  0  1  2  3  4  5  6  7  8  9  A  B  C  D  E  F      ASCII
-----
0000 | 41 72 63 45 6E 63 72 79 70 74 69 6F 6E 4B 65 79 ArcEncryptionKey
0010 | 46 69 6C 65 20 20 20 20 20 20 20 20 20 20 20 20 File
0020 | 20 20 20 20 20 20 20 20 20 20 20 20 20 20 20 20
0030 | 20 20 20 20 20 20 20 20 00 00 00 00 A8 00 00 00 .....
0040 | 41 52 43 2D 31 38 38 33 2D 56 4F 4C 23 30 30 30 ARC-1883-VOL#000
0050 | 34 32 66 66 62 62 31 33 31 34 31 33 34 33 36 37 42ffbb1314134367
0060 | 01 00 40 00 44 78 76 7A 78 63 71 7A 6B 72 6B 6D ..@.Dxvzxcqzkrkm
0070 | 70 61 65 6A 6A 75 6C 65 77 70 62 75 6F 77 6A 75 paejjulewpbuowju
0080 | 72 67 7A 79 7A 77 65 73 7A 76 79 72 76 69 6A 6D rgzyzweszvyrvijs
0090 | 6E 76 6D 71 71 67 76 70 7A 6B 72 62 71 62 64 6A nvmqqgvpzkrbqbdj
00A0 | 6D 74 77 7A 37 15 41 F1 mtwz7.A.
-----
GuiErrMsg<0x00>: Success.
CLI>
```

APPENDIX

The key file is stored on the C:\key

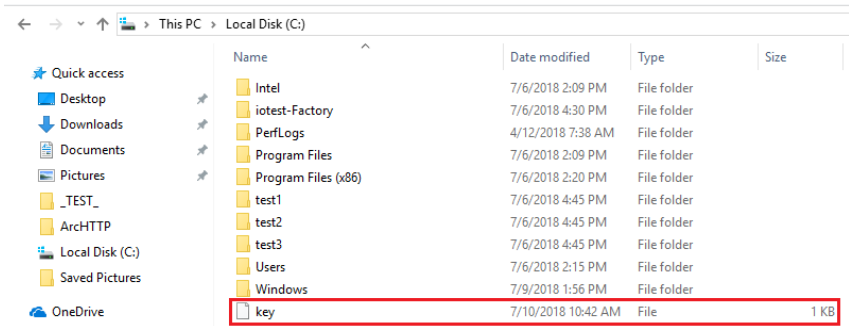

Step 4. Download Volume Key File

Use "Download Volume Key File" in the web management or use CLI "vsf dlkey" command to download volume key file into firmware and unlock the volume.

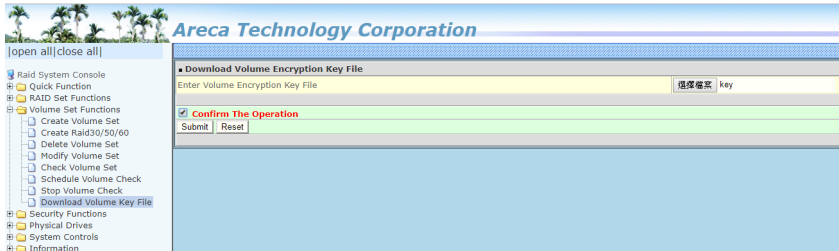

After you submit the key file, the following message is shown:

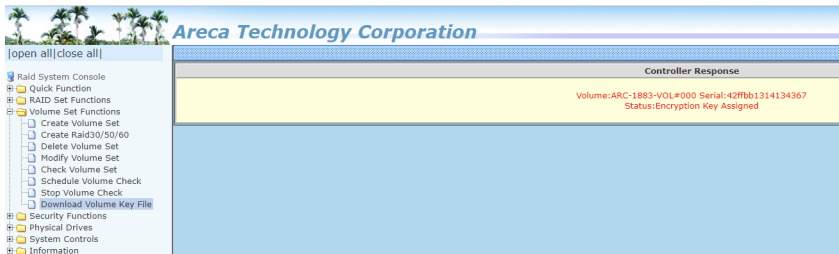

In the Volume Set Information, it is changed to "Encrypted, Unlocked" status.

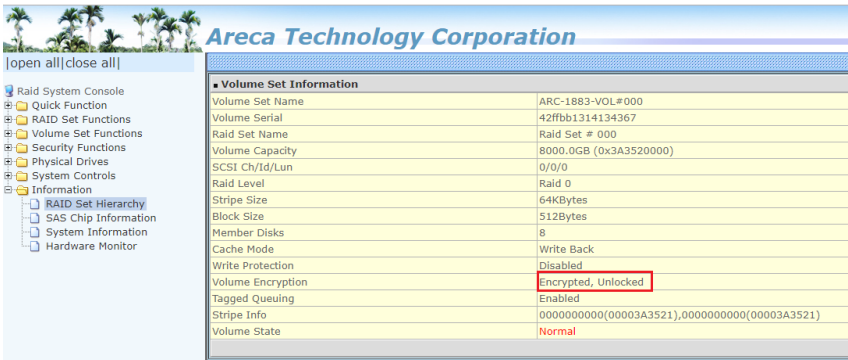

The unencrypted volume is visible in the system Disk Management.

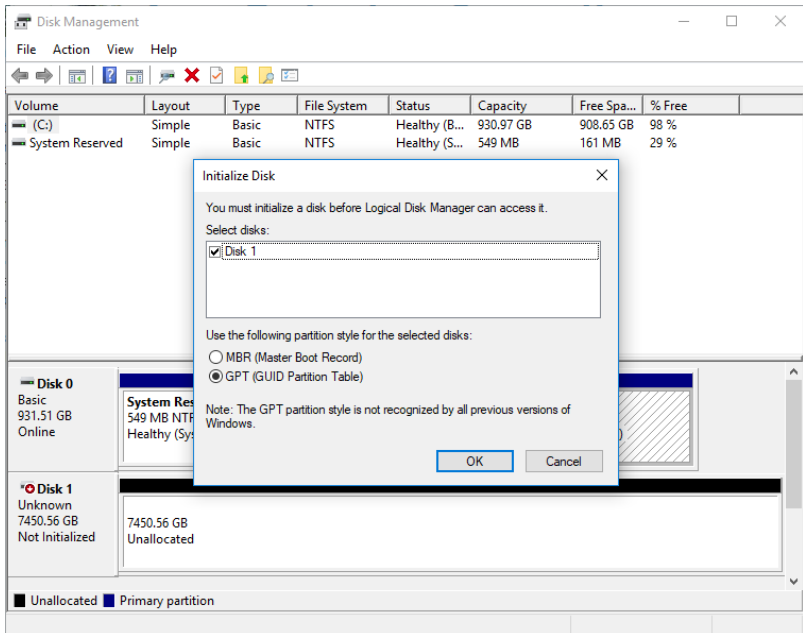

Follow step 4. to unlock volume if volume locked.

APPENDIX

Appendix H

RAID Concept

RAID Set

A RAID set is a group of disks connected to a RAID controller. A RAID set contains one or more volume sets. The RAID set itself does not define the RAID level (0, 1, 1E, 3, 5, 6, 10, 30, 50, 60, etc); the RAID level is defined within each volume set. Therefore, volume sets are contained within RAID sets and RAID Level is defined within the volume set. If physical disks of different capacities are grouped together in a RAID set, then the capacity of the smallest disk will become the effective capacity of all the disks in the RAID set.

Volume Set

Each volume set is seen by the host system as a single logical device (in other words, a single large virtual hard disk). A volume set will use a specific RAID level, which will require one or more physical disks (depending on the RAID level used). RAID level refers to the level of performance and data protection of a volume set. The capacity of a volume set can consume all or a portion of the available disk capacity in a RAID set. Multiple volume sets can exist in a RAID set. For the RAID controller, a volume set must be created either on an existing RAID set or on a group of available individual disks (disks that are about to become part of a RAID set). If there are pre-existing RAID sets with available capacity and enough disks for the desired RAID level, then the volume set can be created in the existing RAID set of the user's choice.

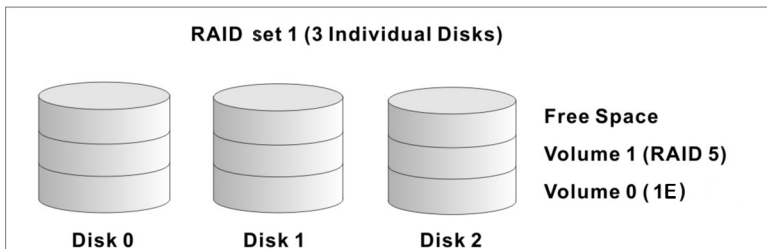

In the illustration, volume 1 can be assigned a RAID level 5 of operation while volume 0 might be assigned a RAID level 1E of operation. Alternatively, the free space can be used to create volume 2, which could then be set to use RAID level 5.

Ease of Use Features

- **Foreground Availability/Background Initialization**

RAID 0 and RAID 1 volume sets can be used immediately after creation because they do not create parity data. However, RAID 3, 5, 6, 30, 50 or 60 volume sets must be initialized to generate parity information. In Background Initialization, the initialization proceeds as a background task, and the volume set is fully accessible for system reads and writes. The operating system can instantly access the newly created arrays without requiring a reboot and without waiting for initialization to complete. Furthermore, the volume set is protected against disk failures while initialing. If using Foreground Initialization, the initialization process must be completed before the volume set is ready for system accesses.

- **Online Array Roaming**

RAID controllers store RAID configuration information on the disk drives. The controller therefore protects the configuration settings in the event of controller failure. Online array roaming allows the administrators the ability to move a complete RAID set to another system without losing RAID configuration information or data on that RAID set. Therefore, if a server fails, the RAID set disk drives can be moved to another server with an Areca RAID controllers and the disks can be inserted in any order.

- **Online Capacity Expansion**

Online Capacity Expansion makes it possible to add one or more physical drives to a volume set without interrupting server operation, eliminating the need to backup and restore after reconfiguration of the RAID set. When disks are added to a RAID set, unused capacity is added to the end of the RAID

APPENDIX

set. Then, data on the existing volume sets (residing on the newly expanded RAID set) is redistributed evenly across all the disks. A contiguous block of unused capacity is made available on the RAID set. The unused capacity can be used to create additional volume sets.

A disk, to be added to a RAID set, must be in normal mode (not failed), free (not spare, in a RAID set, or passed through to host) and must have at least the same capacity as the smallest disk capacity already in the RAID set.

Capacity expansion is only permitted to proceed if all volumes on the RAID set are in the normal status. During the expansion process, the volume sets being expanded can be accessed by the host system. In addition, the volume sets with RAID level 1, 10, 3, 5 or 6 are protected against data loss in the event of disk failure(s). In the case of disk failure, the volume set changes from "migrating" state to "migrating+degraded" state. When the expansion is completed, the volume set would then transition to "degraded" mode. If a global hot spare is present, then it further changes to the "rebuilding" state.

The expansion process is illustrated as following figure.

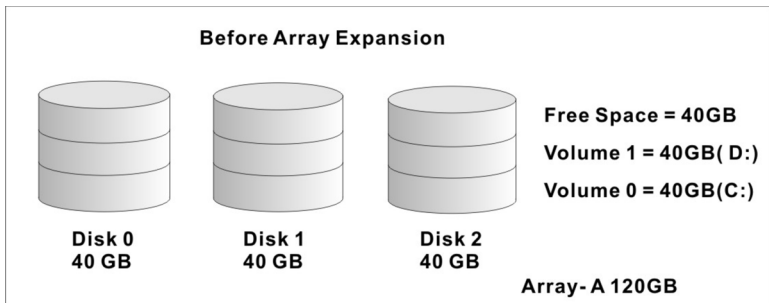

RAID controller redistributes the original volume set over the original and newly added disks, using the same fault-tolerance configuration. The unused capacity on the expand RAID set can then be used to create an additional volume set, with a different fault tolerance setting (if required by the user.)

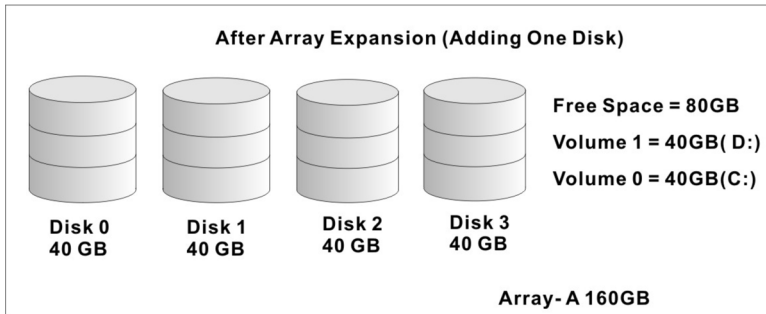

● Online RAID Level and Stripe Size Migration

For those who wish to later upgrade to any RAID capabilities, a system with online RAID level/stripe size migration allows a simplified upgrade to any supported RAID level without having to reinstall the operating system.

The RAID controllers can migrate both the RAID level and stripe size of an existing volume set, while the server is on line and the volume set is in use. Online RAID level/stripe size migration can prove helpful during performance tuning activities as well as when additional physical disks are added to the RAID controller. For example, in a system using two drives in RAID level 1, it is possible to add a single drive and add capacity and retain fault tolerance. (Normally, expanding a RAID level 1 array would require the addition of two disks). A third disk can be added to the existing RAID logical drive and the volume set can then be migrated from RAID level 1 to 5. The result would be parity fault tolerance and double the available capacity without taking the system down. A fourth disk could be added to migrate to RAID level 6. It is only possible to migrate to a higher RAID level by adding a disk; disks in an existing array can't be reconfigured for a higher RAID level without adding a disk.

Online migration is only permitted to begin, if all volumes to be migrated are in the normal mode. During the migration process, the volume sets being migrated are accessed by the host system. In addition, the volume sets with RAID level 1, 1E, 10, 3, 5 or 6 are protected against data loss in the event

APPENDIX

of disk failure(s). In the case of disk failure, the volume set transitions from migrating state to (migrating+degraded) state. When the migration is completed, the volume set transitions to degraded mode. If a global hot spare is present, then it further transitions to rebuilding state.

● **Online Volume Expansion**

Performing a volume expansion on the controller is the process of growing only the size of the latest volume. A more flexible option is for the array to concatenate an additional drive into the RAID set and then expand the volumes on the fly. This happens transparently while the volumes are online, but, at the end of the process, the operating system will detect free space at after the existing volume.

Windows, NetWare and other advanced operating systems support volume expansion, which enables you to incorporate the additional free space within the volume into the operating system partition. The operating system partition is extended to incorporate the free space so it can be used by the operating system without creating a new operating system partition.

You can use the Diskpart.exe command line utility, included with Windows Server 2003 or the Windows 2000 Resource Kit, to extend an existing partition into free space in the dynamic disk.

Third-party software vendors have created utilities that can be used to repartition disks without data loss. Most of these utilities work offline. Partition Magic is one such utility.

High availability

● **Global/Local Hot Spares**

A hot spare is an unused online available drive, which is ready for replacing the failure disk. The hot spare is one of the most important features that RAID controllers provide to deliver a

high degree of fault-tolerance. A hot spare is a spare physical drive that has been marked as a hot spare and therefore is not a member of any RAID set. If a disk drive used in a volume set fails, then the hot spare will automatically take its place and the data previously located on the failed drive is reconstructed on the hot spare.

Dedicated hot spare is assigned to serve one specified RAID set. Global hot spare is assigned to serve all RAID set on the RAID controller. Dedicated hot spare has higher priority than the global hot spare. For this feature to work properly, the hot spare must have at least the same capacity as the drive it replaces. The hot spare function only works with RAID level 1, 1E, 3, 5, 6, 10, 30, 50, or 60 volume set.

The "Create Hot Spare" option gives you the ability to define a global/dedicated hot spare disk drive. To effectively use the hot spare feature, you must always maintain at least one drive that is marked as a global hot spare.

Important:

The hot spare must have at least the same capacity as the drive it replaces.

● **Hot-Swap Disk Drive Support**

The RAID controller chip includes a protection circuit that supports the replacement of SAS/SATA hard disk drives without having to shut down or reboot the system. A removable hard drive tray can deliver "hot swappable" fault-tolerant RAID solutions. This feature provides advanced fault tolerant RAID protection and "online" drive replacement.

● **Auto Declare Hot-Spare**

If a disk drive is brought online into a system operating in degraded mode, the RAID controllers will automatically declare the new disk as a spare and begin rebuilding the degraded volume. The Auto Declare Hot-Spare function requires that the smallest drive contained within the volume set in which the failure occurred.

APPENDIX

In the normal status, the newly installed drive will be reconfigured an online free disk. But, the newly-installed drive is automatically assigned as a hot spare if any hot spare disk was used to rebuild and without new installed drive replaced it. In this condition, the Auto Declare Hot-Spare status will be disappeared if the RAID subsystem has since powered off/on.

The Hot-Swap function can be used to rebuild disk drives in arrays with data redundancy such as RAID level 1, 1E, 3, 5, 6, 10, 30, 50 and 60.

● Auto Rebuilding

If a hot spare is available, the rebuild starts automatically when a drive fails. The RAID controllers automatically and transparently rebuild failed drives in the background at user-definable rebuild rates.

If a hot spare is not available, the failed disk drive must be replaced with a new disk drive so that the data on the failed drive can be automatically rebuilt and so that fault tolerance can be maintained.

RAID controllers will automatically restart the system and rebuilding process if the system is shut down or powered off abnormally during a reconstruction procedure condition.

When a disk is hot swapped, although the system is functionally operational, the system may no longer be fault tolerant. Fault tolerance will be lost until the removed drive is replaced and the rebuild operation is completed.

During the automatic rebuild process, system activity will continue as normal, however, the system performance and fault tolerance will be affected.

● Adjustable Rebuild Priority

Rebuilding a degraded volume incurs a load on the RAID subsystem. The RAID controllers allow the user to select the

rebuild priority to balance volume access and rebuild tasks appropriately. The Background Task Priority is a relative indication of how much time the controller devotes to a background operation, such as rebuilding or migrating.

RAID controller allows user to choose the task priority (Ultra Low (5%), Low (20%), Medium (50%), High (80%)) to balance volume set access and background tasks appropriately. For high array performance, specify an Ultra Low value. Like volume initialization, after a volume rebuilds, it does not require a system reboot.

High Reliability

● Hard Drive Failure Prediction

In an effort to help users avoid data loss, disk manufacturers are now incorporating logic into their drives that acts as an "early warning system" for pending drive problems. This system is called SMART. The disk integrated controller works with multiple sensors to monitor various aspects of the drive's performance, determines from this information if the drive is behaving normally or not, and makes available status information to SAS RAID controller firmware that probes the drive and look at it.

The SMART can often predict a problem before failure occurs. The controllers will recognize a SMART error code and notify the administer of an impending hard drive failure.

● Auto Reassign Sector

Under normal operation, even initially defect-free drive media can develop defects. This is a common phenomenon. The bit density and rotational speed of disks is increasing every year, and so are the potential of problems. Usually a drive can internally remap bad sectors without external help using cyclic redundancy check (CRC) checksums stored at the end of each sector.

APPENDIX

The RAID controller drives perform automatic defect reassignment for both read and write errors. Writes are always completed - if a location to be written is found to be defective, the drive will automatically relocate that write command to a new location and map out the defective location. If there is a recoverable read error, the correct data will be transferred to the host and that location will be tested by the drive to be certain the location is not defective. If it is found to have a defect, data will be automatically relocated, and the defective location is mapped out to prevent future write attempts.

In the event of an unrecoverable read error, the error will be reported to the host and the location will be flagged as being potentially defective. A subsequent write to that location will initiate a sector test and relocation should that location prove to have a defect. Auto Reassign Sector does not affect disk subsystem performance because it runs as a background task. Auto Reassign Sector discontinues when the operating system makes a request.

● Consistency Check

A consistency check is a process that verifies the integrity of redundant data. To verify RAID 3, 5, 6, 30, 50 or 60 redundancy, a consistency check reads all associated data blocks, computes parity, reads parity, and verifies that the computed parity matches the read parity.

Consistency checks are very important because they detect and correct parity errors or bad disk blocks in the drive. A consistency check forces every block on a volume to be read, and any bad blocks are marked; those blocks are not used again. This is critical and important because a bad disk block can prevent a disk rebuild from completing. We strongly recommend that you run consistency checks on a regular basis — at least once per week. Note that consistency checks degrade performance, so you should run them when the system load can tolerate it.

Data Protection

- **Battery Backup**

The RAID controllers are armed with a Battery Backup Module (BBM). While a Uninterruptible Power Supply (UPS) protects most servers from power fluctuations or failures, a BBM provides an additional level of protection. In the event of a power failure, a BBM supplies power to retain data in the RAID controller's cache, thereby permitting any potentially dirty data in the cache to be flushed out to secondary storage when power is restored.

The batteries in the BBM are recharged continuously through a trickle-charging process whenever the system power is on. The batteries protect data in a failed server for up to three or four days, depending on the size of the memory module. Under normal operating conditions, the batteries last for three years before replacement is necessary.

- **Recovery ROM**

RAID controller firmware is stored on the flash ROM and is executed by the I/O processor. The firmware can also be updated through the RAID controllers PCIe bus port or Ethernet port without the need to replace any hardware chips. During the controller firmware upgrade flash process, it is possible for a problem to occur resulting in corruption of the controller firmware. With our Redundant Flash Image feature, the controller will revert back to the last known version of firmware and continue operating. This reduces the risk of system failure due to firmware crash.

APPENDIX

Appendix I

Understanding RAID

RAID is an acronym for Redundant Array of Independent Disks. It is an array of multiple independent hard disk drives that provides high performance and fault tolerance. The RAID controller implements several levels of the Berkeley RAID technology. An appropriate RAID level is selected when the volume sets are defined or created. This decision should be based on the desired disk capacity, data availability (fault tolerance or redundancy), and disk performance. The following section discusses the RAID levels supported by the RAID controllers.

The RAID controllers makes the RAID implementation and the disks' physical configuration transparent to the host operating system. This means that the host operating system drivers and software utilities are not affected, regardless of the RAID level selected. Correct installation of the disk array and the controller requires a proper understanding of RAID technology and the concepts.

RAID 0

RAID 0, also referred to as striping, writes stripes of data across multiple disk drives instead of just one disk drive. RAID 0 does not provide any data redundancy, but does offer the best high-speed data throughput. RAID 0 breaks up data into smaller blocks and then writes a block to each drive in the array. Disk striping enhances performance because multiple drives are accessed simultaneously; the reliability of RAID level 0 is less because the entire array will fail if any one disk drive fails.

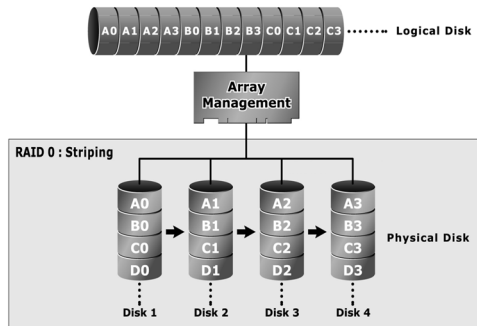

RAID 1 - Simple Mirroring

RAID 1-Simple Mirroring is also known as “two disk mirror”; data written on one disk drive is simultaneously written to another disk drive. Read performance will be enhanced if the array controller can, in parallel, access both members of a mirrored pair. During writes, there will be a minor performance penalty when compared to writing to a single disk. If one drive fails, all data (and software applications) are preserved on the other drive. RAID 1-Simple Mirroring offers extremely high data reliability, but at the cost of doubling the required data storage capacity. HDDs and SSDs have different characteristics. If you combine an SSD and a HDD in a RAID1-Simple Mirroring hybrid solution, you can get all the reads from the SSD with SSD speed and at the same time have the redundancy of RAID1 without the need to buy a second, expensive SSD.

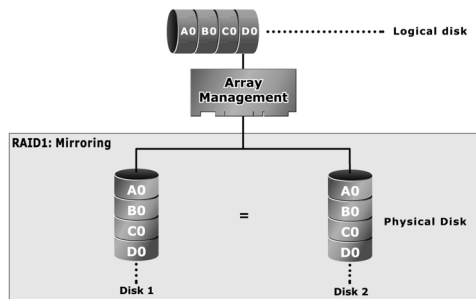

APPENDIX

RAID 1 - Multi Mirroring

RAID 1-Multi Mirroring is also known as “triple disk mirror”; data written on one disk drive is simultaneously written to another two disk drives. Read performance will be enhanced if the array controller can, in parallel, access all members of multi mirrored drives. During writes, there will be a minor performance penalty when compared to writing to a single disk. If one or two drive fails, all data (and software applications) are preserved on the healthy drive. RAID 1-Multi Mirroring writes three copies of everything, but its data storage capacity effective is 33.3%. HDDs and SSDs have different characteristics. If you combine an SSD and a HDD in a RAID1-Multi Mirroring hybrid solution, you can get all the reads from the SSD with SSD speed and at the same time have the redundancy of RAID1 without the need to buy a second, expensive SSD.

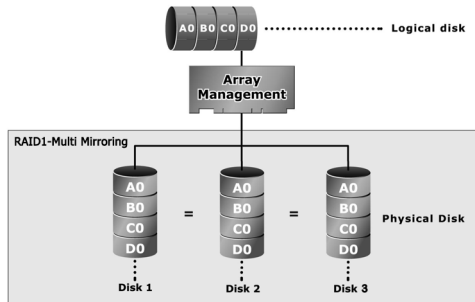

RAID 10(1E)

RAID 10(1E) is a combination of RAID 0 and RAID 1, combining striping with disk mirroring. RAID Level 10 combines the fast performance of Level 0 with the data redundancy of level 1. In this configuration, data is distributed across several disk drives, similar to Level 0, which are then duplicated to another set of drive for data protection. RAID 10 has been traditionally implemented using an even number of disks, some hybrids can use an odd number of disks as well. Illustration is an example of a hybrid RAID 10(1E) array comprised of five disks; A, B, C, D and E. In this configuration, each strip is mirrored on an adjacent disk with wrap-around. Areca RAID 10 offers a little more flexibility in choosing the number of disks that can be used to constitute an array. The number can be even or odd.

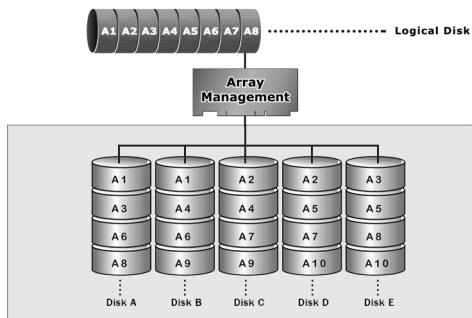

RAID 3

RAID 3 provides disk striping and complete data redundancy through a dedicated parity drive. RAID 3 breaks up data into smaller blocks, calculates parity by performing an exclusive-or on the blocks, and then writes the blocks to all but one drive in the array. The parity data created during the exclusive-or is then written to the last drive in the array. If a single drive fails, data is still available by computing the exclusive-or of the contents corresponding strips of the surviving member disk. RAID 3 is best for applications that require very fast data-transfer rates or long data blocks.

APPENDIX

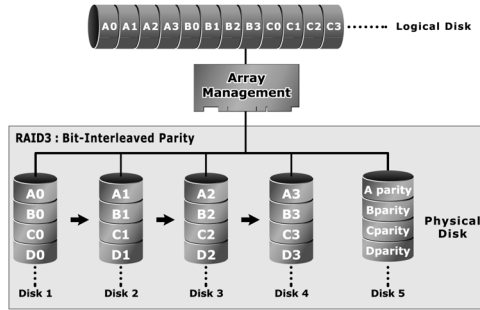

RAID 5

RAID 5 is sometimes called striping with parity at byte level. In RAID 5, the parity information is written to all of the drives in the controllers rather than being concentrated on a dedicated parity disk. If one drive in the system fails, the parity information can be used to reconstruct the data from that drive. All drives in the array system can be used for seek operations at the same time, greatly increasing the performance of the RAID system. This relieves the write bottleneck that characterizes RAID 4, and is the primary reason that RAID 5 is more often implemented in RAID arrays.

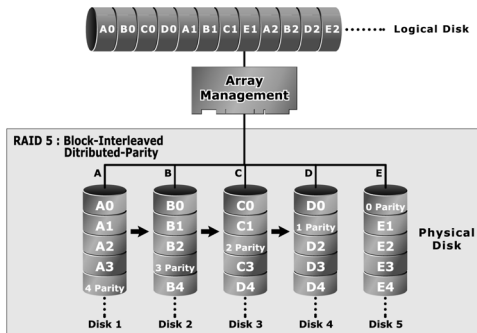

RAID 6

RAID 6 provides the highest reliability. It is similar to RAID 5, but it performs two different parity computations or the same computation on overlapping subsets of the data. RAID 6 can offer fault tolerance greater than RAID 1 or RAID 5 but only consumes the capacity of 2 disk drives for distributed parity data. RAID 6 is an extension of RAID 5 but uses a second, independent distributed parity scheme. Data is striped on a block level across a set of drives, and then a second set of parity is calculated and written across all of the drives.

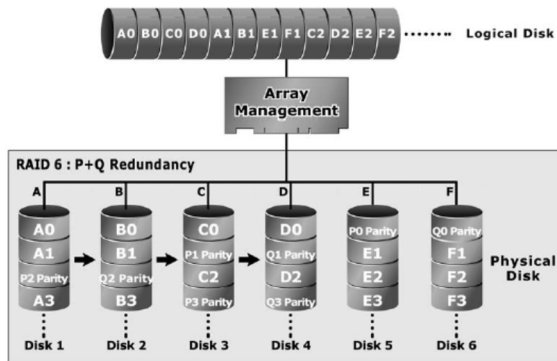

RAID x0

RAID level-x0 refers to RAID level 00, 100, 30, 50 and 60. RAID x0 is a combination multiple RAID x volume sets with RAID 0 (striping). Striping helps to increase capacity and performance without adding disks to each RAID x array. The operating system uses the spanned volume in the same way as a regular volume. Up to one drive in each sub-volume (RAID 3 or 5) may fail without loss of data. Up to two drives in each sub-volume (RAID 6) may fail without loss of data. RAID level x0 allows more physical drives in an array. The benefits of doing so are larger volume sets, increased performance, and increased reliability.

The following illustration is an example of a RAID level x0 logical drive.

APPENDIX

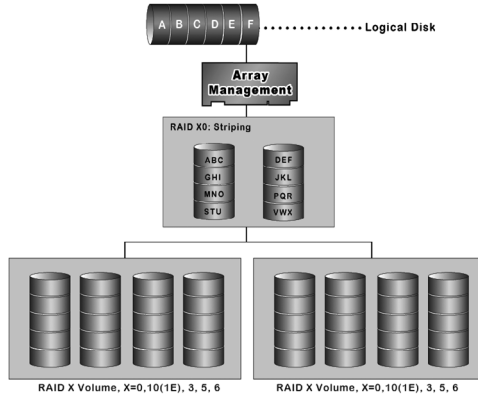

Important:

RAID level 00, 100, 30, 50 and 60 can support up to eight RAID set. If volume is RAID level 00, 100, 30, 50, or 60, you can't change the volume to another RAID level. If volume is RAID level 0, 1, 10(1E), 3, 5, or 6, you can't change the volume to RAID level 00, 100, 30, 50, or 60.

JBOD

(Just a Bunch Of Disks) A group of hard disks in a RAID box are not set up as any type of RAID configuration. All drives are available to the operating system as an individual disk. JBOD does not provide data redundancy.

Single Disk (Mirrored Pass-Through Disk)

Pass-through disks are attached to a RAID controller and operate as if they were attached to a non-RAID controller. No RAID configuration structure is stored on these physical disks. This feature is primarily targeted for users moving physical disks containing data from non-RAID controllers to RAID controllers. The disk is available directly to the operating system as an individual disk. It is typically used on a system where the operating system is on a disk not controlled by the RAID controller firmware. A mirrored pass-through mode means controller will be

regarded as the hard disk clone function, a host's data will write simultaneously into two or three hard disks in the RAID controller. Triple pass-through means "save three copies of the data such that you can survive two disks failure and still have everything." If you combine an SSD and HDDs in a mirrored pass-through hybrid solution, you can get all the reads from the SSD with SSD speed.

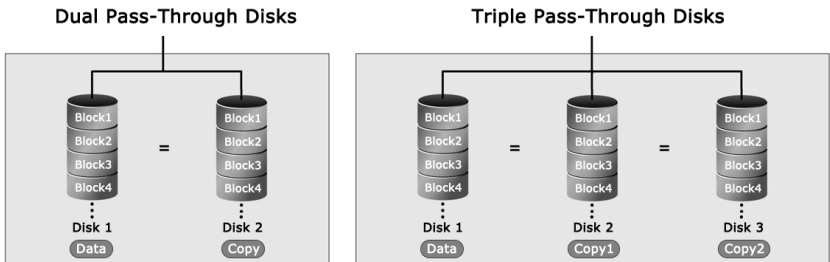

Figure G-1, Dual Pass-Through Disks & Triple Pass-Through Disks

APPENDIX

Summary of RAID Levels

12Gb/s SAS RAID controller supports RAID Level 0, 1, 10(1E), 3, 5, 6, 30, 50, 60 and Pass-Through Disk. The following table provides a summary of RAID levels.

RAID Level Comparison			
RAID Level	Description	Disks Requirement (Minimum)	Data Availability
0	Also known as striping. Data distributed across multiple drives in the array. There is no data protection.	1	No data Protection
1	Also known as simple mirroring. All data replicated on 2 separated disks. N is almost always 2. Due to this is a 100 % duplication, so is a high costly solution.	2	Up to one disk failure
1	Also known as Multi Mirroring. All data replicated on 3 separated disks. N is almost always 3. Due to this is a 100 % duplication, so is a high costly solution.	3	Up to two disks failure
10(1E)	Also known as mirroring and striping. Data is written to two disks simultaneously, and allows an odd number or disk. Read request can be satisfied by data read from wither one disk or both disks.	3	Up to one disk failure in each sub-volume
3	Also known Bit-Interleaved Parity. Data and parity information is subdivided and distributed across all data disks. Parity information normally stored on a dedicated parity disk.	3	Up to one disk failure
5	Also known Block-Interleaved Distributed Parity. Data and parity information is subdivided and distributed across all disk. Parity information normally is interspersed with user data.	3	Up to one disk failure
6	RAID 6 provides highest reliability, but not widely used. Similar to RAID 5, but does two different parity computations or the same computation on overlapping subsets of the data. The RAID 6 can offer fault tolerance greater that RAID 1 or RAID 5 but only consumes the capacity of 2 disk drives for distributed parity data.	4	Up to two disk failure

APPENDIX

30	RAID 30 is a combination multiple RAID 3 volume sets with RAID 0 (striping)	6	Up to one disk failure in each sub-volume
50	RAID 50 is a combination multiple RAID 5 volume sets with RAID 0 (striping)	6	Up to one disk failure in each sub-volume
60	RAID 60 is a combination multiple RAID 6 volume sets with RAID 0 (striping)	8	Up to two disk failure in each sub-volume
Pass-Through Disk	Pass-Through disk is attached to a RAID controller and operate as if they were attached to a non-RAID controller. No RAID configuration structure is stored on these physical disks.	1	No data Protection
Pass-Through Disk	Dual pass-through disks mean "save two copies of the data such that you can survive one disk failure and still have everything."	2	Up to one disk failure
Pass-Through Disk	Triple pass-through disks mean "save three copies of the data such that you can survive two disks failure and still have everything."	3	Up to two disks failure